

Genuine Accessories



Vehicle Model: **Veloster**

Model Year 2019~
 Part No. J3F17 AU000 (DIO)
 J3F17 AU600 (PIO)
 Language English
 Rev. Date 5/23/2019

Accessory: **Cargo Net**

Difficulty: (A)

Note: Difficulty stated above reflects the minimum level of expertise required to install the accessory:
 (A) Customer
 (B) Dealer Technician
 (C) Master Technician or Specialist

Electronic Installation Instructions



If this is a printed copy of the installation instructions, ensure you have the latest revision by scanning the QR code or by entering the website address listed below before beginning installation. Use the latest revision date as noted by "Rev. Date" above.

www.hyundaiaccessories.com/admin_media_uploads/installationSheets/j3f17_au000.pdf

Application Notes

2020 model year and newer are factory equipped with cargo D-rings therefore, step 1 though 5 do not apply.

Instructional Symbols / Definitions

	Denotes warnings that may lead to serious physical injury or vehicle damage		Denotes quality processes to be checked prior to moving to the next step	Denotes personal protective equipment (PPEs) that may be required for a step. Examples of safety equipment icons noted below:	
	Denotes cautions to be taken to avoid physical injury or electronic component damage		Denotes specific tools that are necessary to complete a step		
	Denotes cautions to be taken to avoid vehicle and component damage	N O T E	Denotes important information to be reviewed during the step		
				Glasses	Gloves
				Mask	Hearing Protection

Basic Required Tools (2019 Model Year Only)

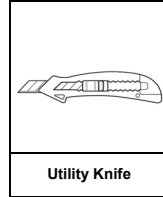
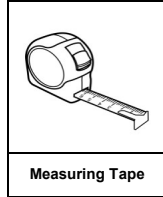
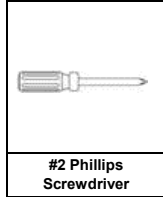
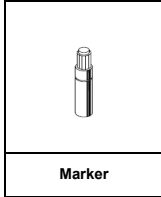

Basic Required Tools (2020~ Model Years Only)

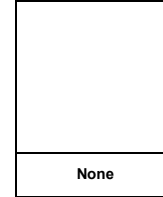

Part Weight (Gross) (2019 Model Year Only)

0.62	lbs
0.28	kg

Part Weight (Gross) (2020~ Model Year Only)

0.26	lbs
0.12	kg

FMVSS 110 Compliance Information

All dealers must determine if the Net weight they have added in the form of all options or accessories, when added to the weight of all Port/Dealer Installed options or accessories, exceeds the lesser of 1.5% of GVWR or 100 lbs. If the additional weight does exceed the lesser of the indicated thresholds, a "Load Carrying Capacity Reduced" label must be installed. A black, fine-point, indelible marker must be used to write by hand onto the label, the reduced carrying capacity in kilograms or pounds, which is the total weight of all added options and accessories.
Load Label Part Number: NP070 - 09003

Notes to the installer:

- 1) Read the entire Installation Instructions prior to beginning the installation of the part.
- 2) Make sure the vehicle is completely clean and dry in the area(s) the part is to be installed.
- 3) Ensure the vehicle is properly protected in the area(s) that the accessory is to be installed.
- 4) NEVER place tools on painted surfaces, seating surfaces, dash pad, console or floor carpet/mats.
- 5) Always wear appropriate personal protective equipment, including gloves, safety glasses, etc., when required.
- 6) **For 2020 model year and newer vehicle, skip to step 6.**

Genuine Accessories

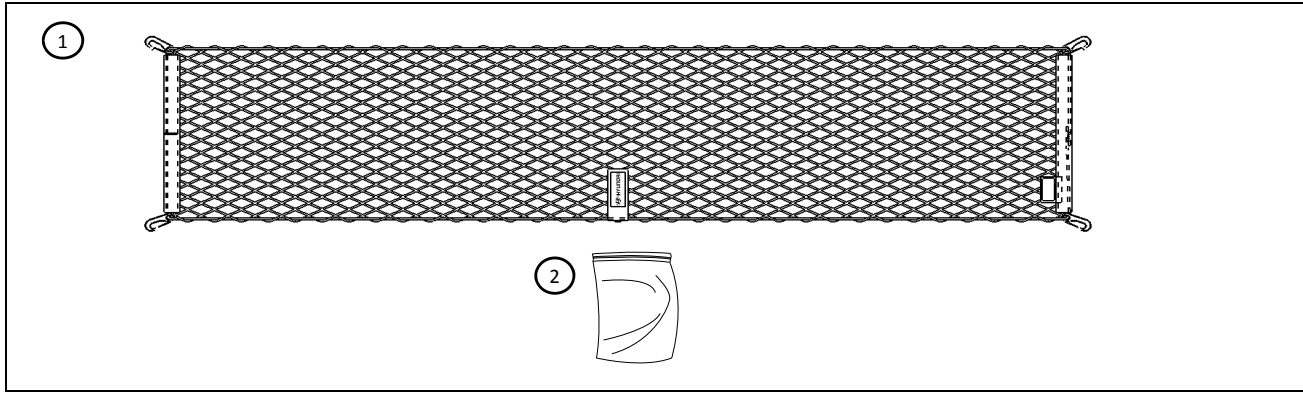

Kit Overview



No.	Qty	Description
1	1	Cargo Net
2	1	Hardware Kit*

*Note: Item #2, *Hardware Kit*, does NOT apply to 2020 model year & newer and must be discarded.



Hardware Kit Contents



A		B	
2	LH D-Ring	2	RH D-Ring

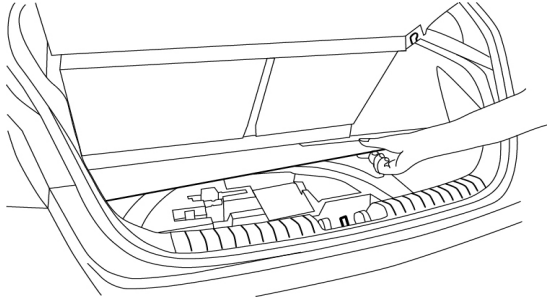

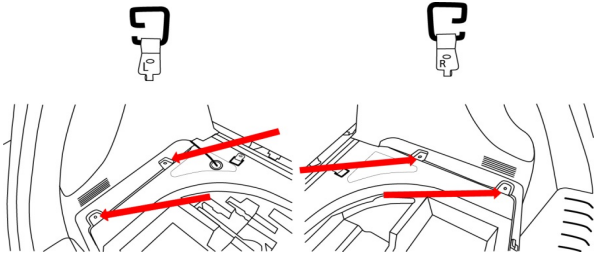
Hardware Total
4

Genuine Accessories

1		
2019 Model Year ONLY		
		
NOTE	<p>A. Open Hatch Lid to access cargo area. B. Lift up and remove the factory load floor from cargo area. C. Store factory load floor in a safe location for reinstallation.</p>	

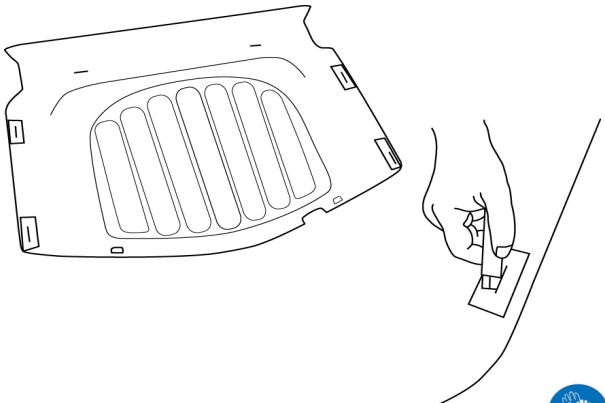

2		#2 Phillips Screwdriver
2019 Model Year ONLY		
		
NOTE	<p>A. Identify "L" and "R" marking on the four (4) D-rings. B. Locate two (2) phillips screws on each side of the cargo area as shown, and temporarily remove. C. Install the two (2) "L" marked D-rings on the driver's side and secure using the factory phillips screws. D. Install the two (2) "R" marked D-rings on the passenger's side and secure using the factory phillips screws. E. Tighten the four (4) screws until snug.</p>	
	Do not over-tighten screws.	

3		Masking Tape, Marker, Measuring Tape
2019 Model Year ONLY		
		
NOTE	<p>A. Position and align the factory load floor back into the cargo area. Ensure the two (2) child seat anchors and the two (2) rear positioning tabs are protruding through the factory load floor. B. Place four (4) pieces of masking tape onto the factory load floor over each raised area of the factory load floor in relation to the D-rings underneath. C. Using a marker, mark a line (approximately 35mm (1.4") in length) onto the masking tape over the highest raised area where the D-rings are located under the factory load floor.</p>	

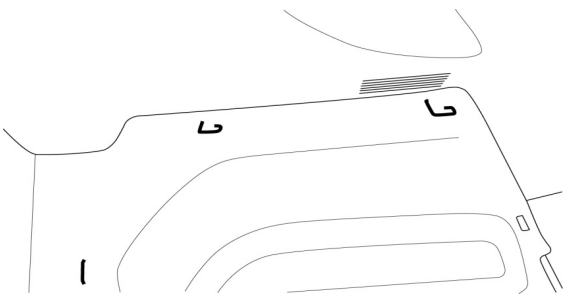

4		Utility Knife
2019 Model Year ONLY		
		
NOTE	<p>A. Remove the factory load floor from the vehicle and place on a flat, clean surface. B. Using a Utility Knife, cut marked lines on each masking tape through the factory load floor carpet approximately 35mm (1.4") in length, parallel to the edge of the factory load floor. C. Remove and discard the four (4) pieces of tape.</p>	
		

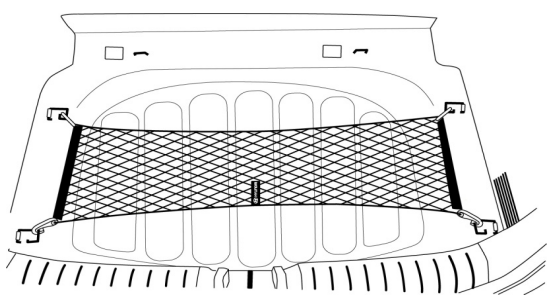
Genuine Accessories

5		<div style="border: 1px solid black; padding: 5px; text-align: center; color: red; font-weight: bold; margin-bottom: 20px;">2019 Model Year ONLY</div> 
NOTE	<p>A. Position and align the factory load floor back into the cargo area. Ensure the two (2) child seat anchors and the two (2) rear positioning tabs are protruding through the factory load floor.</p> <p>B. Feed the D-rings through the slits of the factory load floor.</p>	

6		
NOTE	<p>2020 & Newer Model Years Only</p> <p>A. Open Hatch Lid to access cargo area. B. Locate the four (4) D-rings.</p> <p>2019 & Newer Model Years</p> <p>A. Position the Cargo Net so the Plastic Pull Handle is facing rearward. B. Attach the Hooks to the D-rings as shown.</p>	
	<p>Ensure hooks are secure to D-Rings.</p>	

Visual Check

Item to be Checked	Result
 <p>2019 Model Year ONLY Verify the four (4) D-ring screws are snug.</p>	<p>2019 Model Year ONLY D-ring are secured.</p>
 <p>Verify the position of the Cargo Net and Pull Tab.</p>	<p>Pull Tab is facing the rear of the vehicle.</p>
 <p>Ensure hooks are secure to D-Rings.</p>	<p>Hooks are secure to the D-Rings.</p>