



HYUNDAI Genuine Accessories

Vehicle Model Santa Fe
Model Year 2013~
HMA Part No. B8017 ADU10 DIO









Accessory Cargo Net (Pouch)
Difficulty (A)

Note: Difficulty stated above reflects the minimum level of expertise required to install the accessory
 (A) Customer (B) Dealer Technician (C) Master Technician

<p style="text-align: center;">FMVSS 110</p> <p style="text-align: center;">Compliance Information</p>	<p>All dealers must determine if the weight they have added in the form of all options or accessories, when added to the weight of all Port Installed options or accessories, exceeds the lesser of 1.5% of GVWR or 100 lbs. If the additional weight does exceed the lesser of the indicated thresholds, a "Load Carrying Capacity Reduced" label must be installed. A black, fine-point, indelible marker must be used to write by hand onto the label, the reduced carrying capacity in kilograms or pounds, which is the total weight of all added options and accessories.</p> <p>Load Label Part Number: NP070-09003</p>
<p>Part Number: B8017 ADU10 1.3 lbs (Gross Weight)</p>	

- Accessory Installation

Instructional Symbols / Definitions

 Denotes warnings that may lead to serious physical injury or vehicle damage.  Denotes cautions to be taken to avoid physical injury or electronic component damage.  Denotes cautions to be taken to avoid vehicle and component damage.	 Denotes quality processes to be checked prior to moving to the next step.  Denotes specific tools that are necessary to complete the step. <div style="background-color: blue; color: white; padding: 2px; text-align: center; width: 20px; margin: 5px auto;">NOTE</div> Denotes instructional steps necessary to complete the process.	Denotes safety equipment required to be used such as a mask, goggles, rubber gloves, and hearing protection. <div style="display: flex; justify-content: space-around; align-items: center;"> <div style="text-align: center;">  Mask </div> <div style="text-align: center;">  Goggles </div> </div> <div style="display: flex; justify-content: space-around; align-items: center; margin-top: 10px;"> <div style="text-align: center;">  Rubber Gloves </div> <div style="text-align: center;">  Hearing Protection </div> </div>
--	---	---

Basic Required Hand Tools:

None

WARNING: Cargo nets are constructed of elastic and netting. Please use caution to avoid entanglement. Avoid eye injury. **DO NOT** overstretch the cargo net. **ALWAYS**, keep your face and body out of the cargo net's recoil path.

Notes to Installer:

- Read the entire installation pamphlet prior to beginning the installation of the accessory.
- Ensure that the vehicle is properly protected in the area that the accessory is to be installed.
- To prevent vehicle damage, never place tools on top of painted surfaces, seats, dash pad, console or floor carpet / mat.
- Always wear appropriate safety gear to include gloves and eye protection when required.
- After the installation of the net, please place the instructions in the vehicle glove compartment for later use if needed.

HYUNDAI Genuine Accessories

Kit Overview

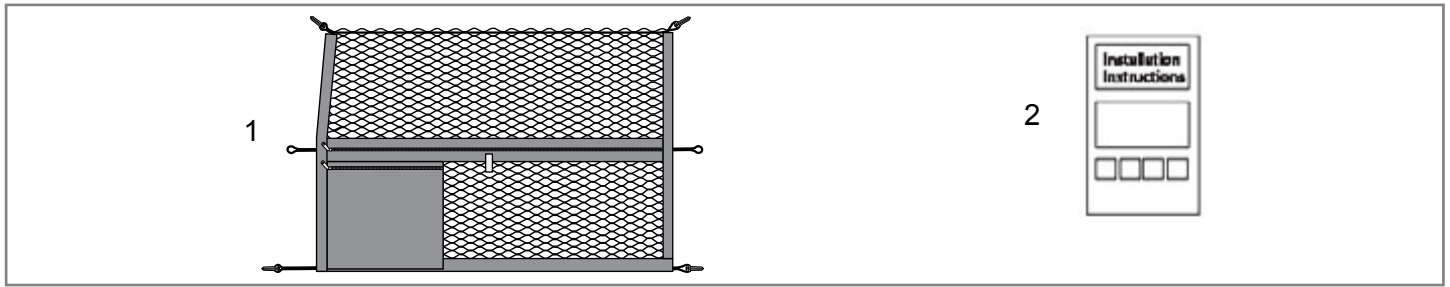

No.	Qty.	Description
1	1	Cargo Net
2	1	Installation Instructions

Instructions

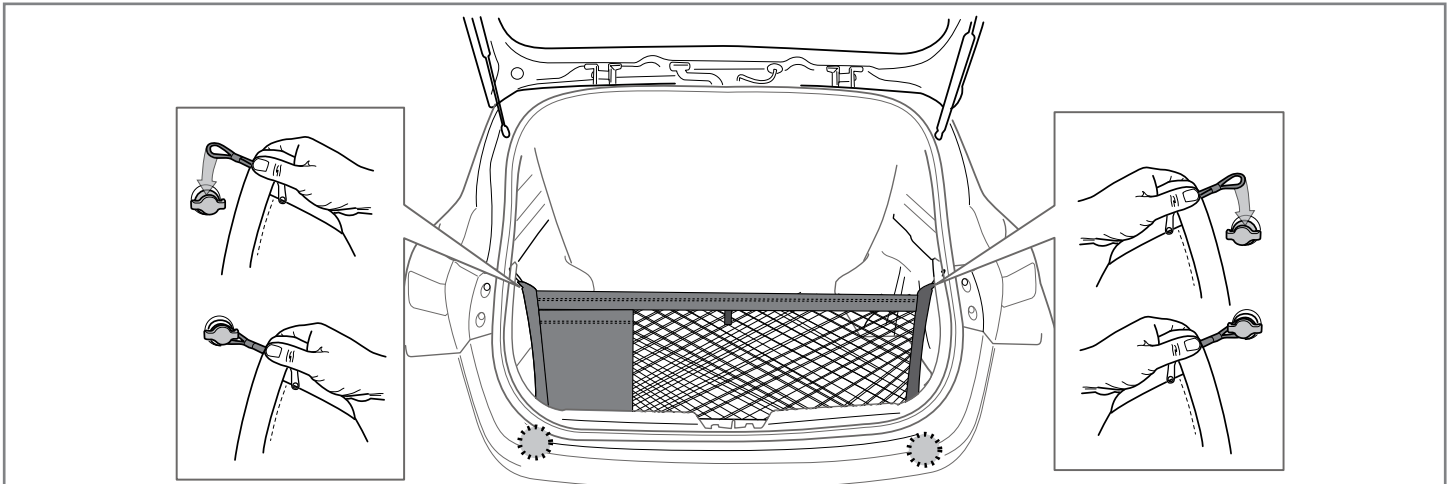



NOTE For vertical installation: Open rear hatch and locate the T-nut and D-ring attachment points as shown. Orient the net with the pouch facing the rear of the vehicle. With the upper section folded over, attach the upper loops of the cargo net to the T-nuts as shown.

1

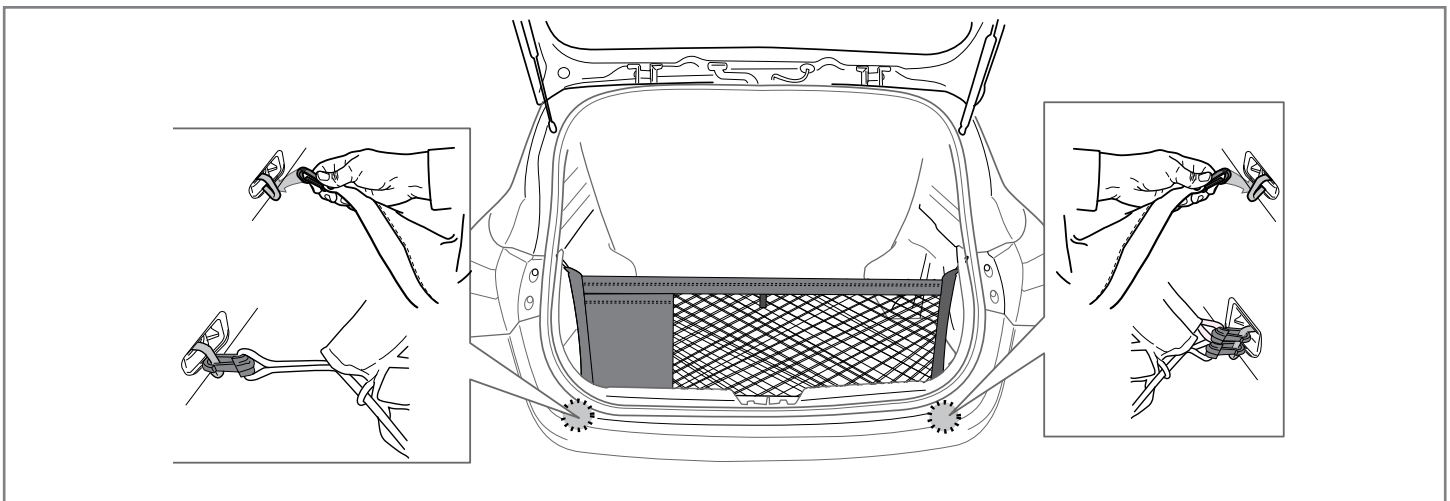



NOTE Locate the lower D-rings. Attach the four (4) plastic clips (front and rear net panels) of the cargo net to the D-rings as shown.

2

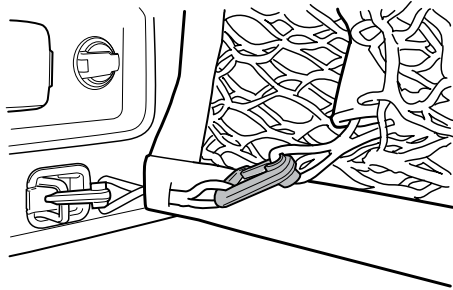

Passenger Side of Net

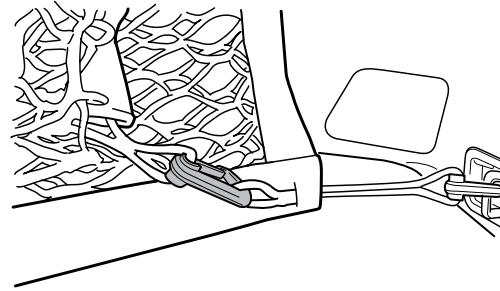

Driver Side of Net



3

NOTE

To secure the rear back panel of the net, attach the two (2) plastic clips to the two (2) sewn loops at the bottom of the front panel

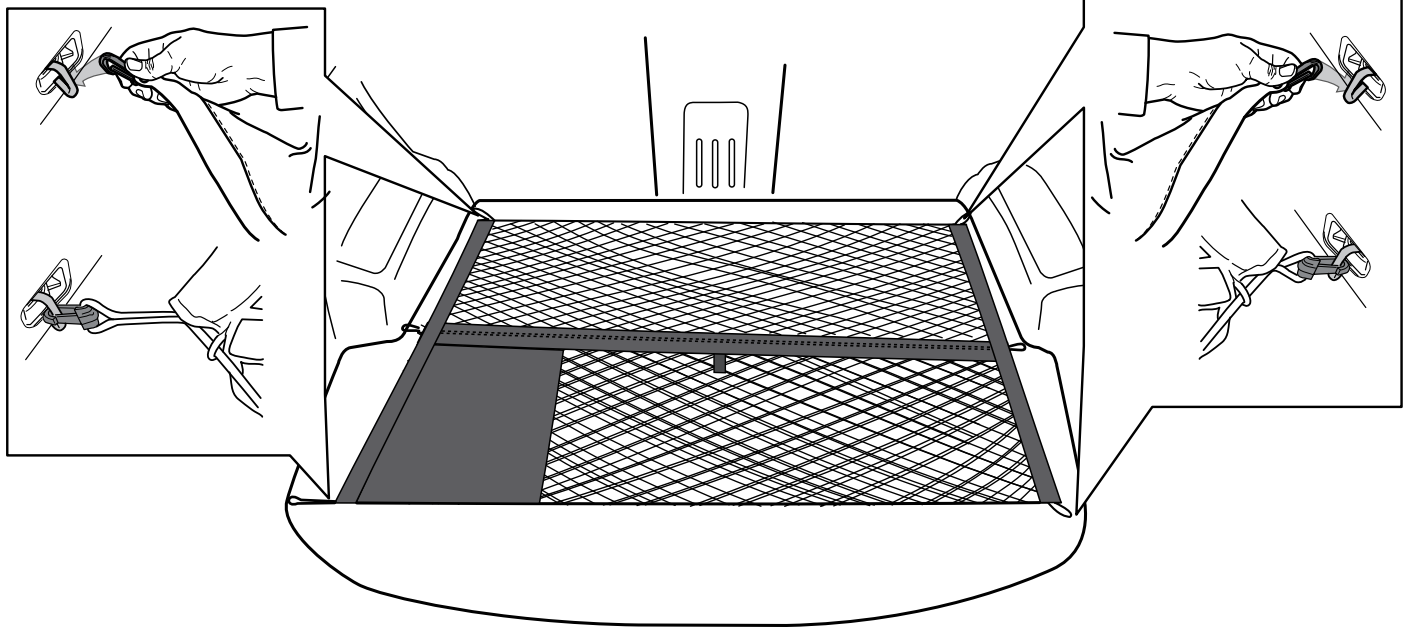

4

NOTE

For horizontal installation: Open rear hatch and locate the four (4) D-ring attachment points as shown. Attach the plastic clips of the cargo net to the D-rings as shown.