



HYUNDAI Genuine Accessories

Vehicle Model	Santa Fe	Accessory	Door Scuff Plates
Model Year	2013~	Difficulty	A
Part No.	B8F45 AC500		

- Accessory Installation

Note: Difficulty stated above reflects the minimum level of expertise required to install the accessory
 (A) Customer (B) Dealer Technician (C) Master Technician

Instructional Symbols / Definitions

	Denotes warnings that may lead to serious physical injury or vehicle damage.		Denotes quality processes to be checked prior to moving to the next step.	Denotes safety equipment required to be used such as a mask, goggles, rubber gloves, and hearing protection.	
	Denotes cautions to be taken to avoid physical injury or electronic component damage.		Denotes specific tools that are necessary to complete the step.		
	Denotes cautions to be taken to avoid vehicle and component damage.	NOTE	Denotes instructional steps necessary to complete the process.		
				Mask	Goggles
				Rubber Gloves	Hearing Protection

Basic Required Hand Tools

Nylon Panel Removal Tool	Lint Free Cloth	50/50 Isopropyl Alcohol (70%) & Water Mix

FMVSS 110 Compliance Information

Part Number:
B8F45 AC500

0.544 KG
1.199 LBS
(Gross Weight)

All dealers must determine if the weight they have added in the form of all options or accessories, when added to the weight of all Port Installed options or accessories, exceeds the lesser of 1.5% of GVWR or 100 lbs. If the additional weight does exceed the lesser of the indicated thresholds, a "Load Carrying Capacity Reduced" label must be installed. A black, fine-point, indelible marker must be used to write by hand onto the label, the reduced carrying capacity in kilograms or pounds, which is the total weight of all added options and accessories.

Load Label Part Number:
NP070 - 09003

Notes to the Installer:

- 1) Read the entire installation pamphlet prior to beginning the installation of this accessory.
- 2) Ensure the vehicle is properly protected in the area(s) that the accessory is to be installed.
- 3) To prevent vehicle damage, never place tools on top of painted surfaces, seats, dash pad, console or floor carpet/mats.
- 4) Always wear appropriate safety gear to include gloves and eye protection when required.

HYUNDAI Genuine Accessories

HYUNDAI Kit Overview

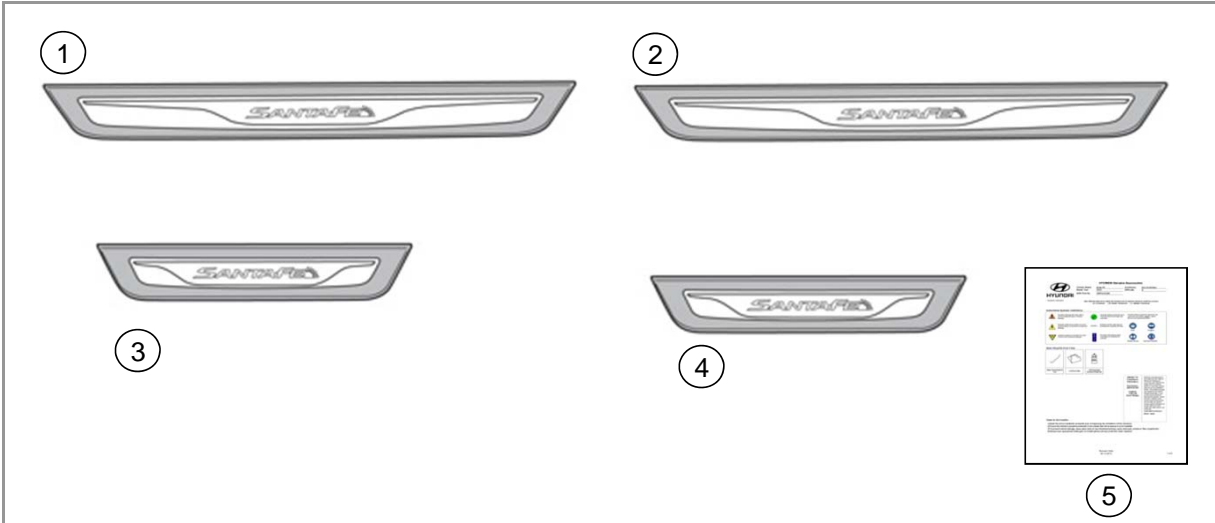

No.	Qty.	Description
1	1	LF Door Scuff Plate (long)
2	1	RF Door Scuff Plate (long)
3	1	LR Door Scuff Plate (short)
4	1	RR Door Scuff Plate (short)
5	1	Instructions.

HYUNDAI Genuine Accessories

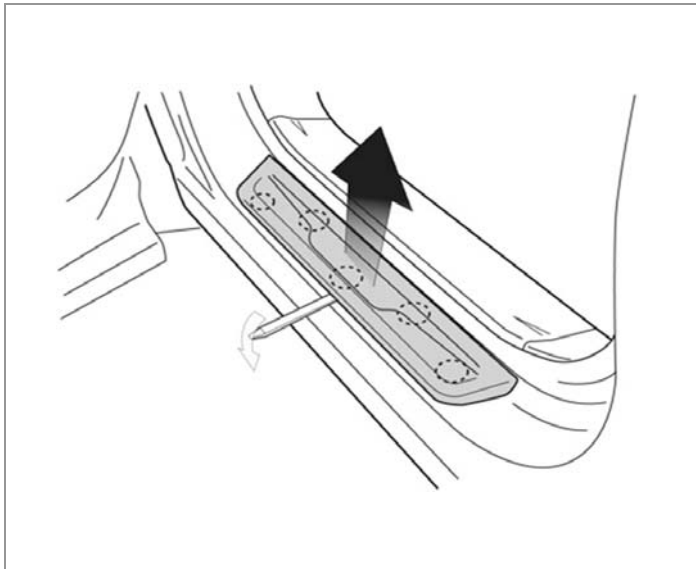

Nylon Panel Removal Tool

1

NOTE

1. Using a nylon panel removal tool, gently pull up to disengage the five (5) retention clips of the left front (LF) OEM door scuff plate and remove from the side panel of the vehicle.
2. Discard the OEM door scuff plate.



Do not scratch or damage the side panel when removing the OEM door scuff plate.

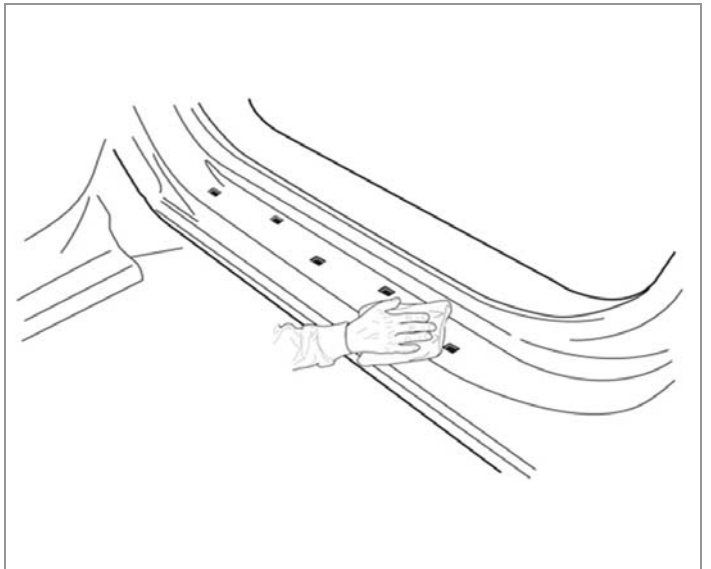

50/50 Isopropyl Alcohol (70%) & Water Mix and Lint Free Cloth

2

NOTE

1. Using a 50/50 isopropyl alcohol (70%) & water mix and a lint free cloth, thoroughly clean the side panel as shown.

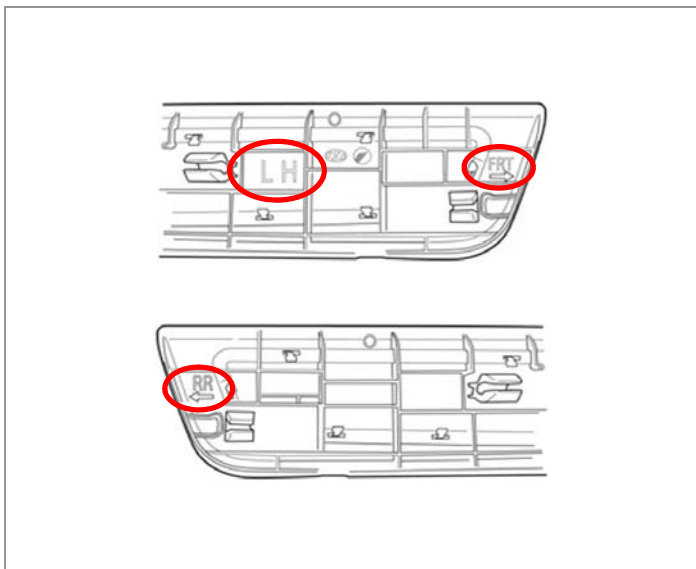

3

NOTE

1. Identify the left front (LF) door scuff plate (long) by the "LH" marking indicated on the backside as shown.
2. Orient the "FRT" and "RR" arrows of the door scuff plate with the front and rear of the vehicle.



Make sure to correctly identify and orient the door scuff plate.

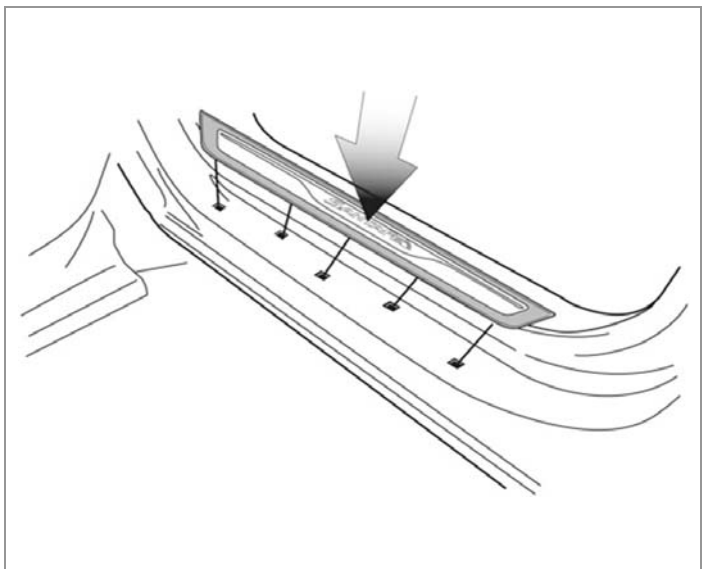

4

NOTE



1. Align the five (5) clips of the left front (LF) door scuff plate (long) to the five (5) front left hand (LH) clip holes of the vehicle side panel as shown.
2. Gently push down on each of the five (5) clip locations to securely fasten the door scuff plate to the vehicle.



Make sure all clips on the door scuff plate are fully inserted into the clip holes of the side panel.

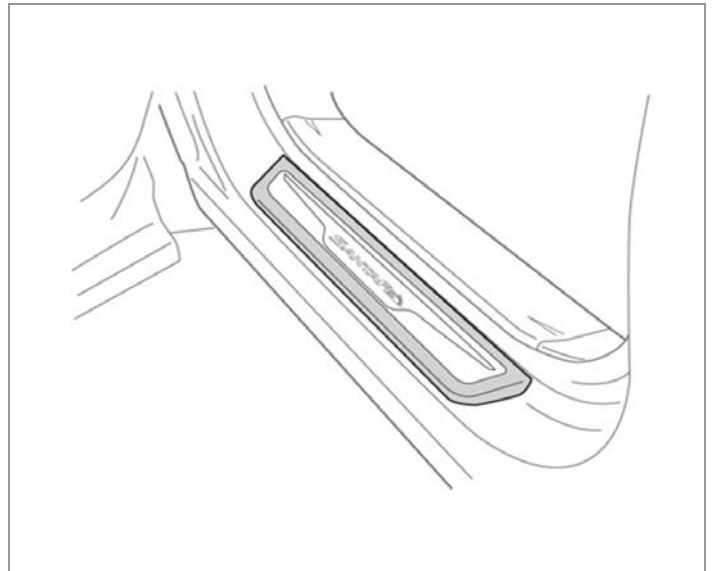
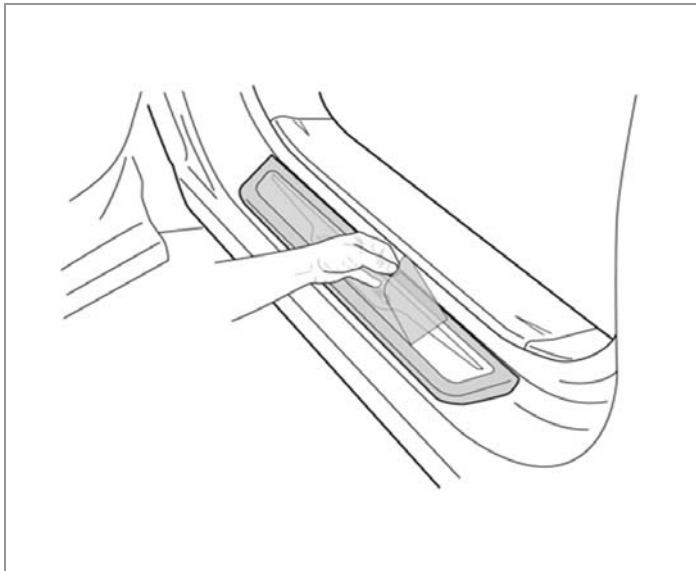

HYUNDAI Genuine Accessories



	5
N O T E	<ol style="list-style-type: none"> 1. Peel the protective film away from the left front (LF) door scuff plate (long) as shown. 2. Discard the protective film.
	Do not scratch or damage the door scuff plate.

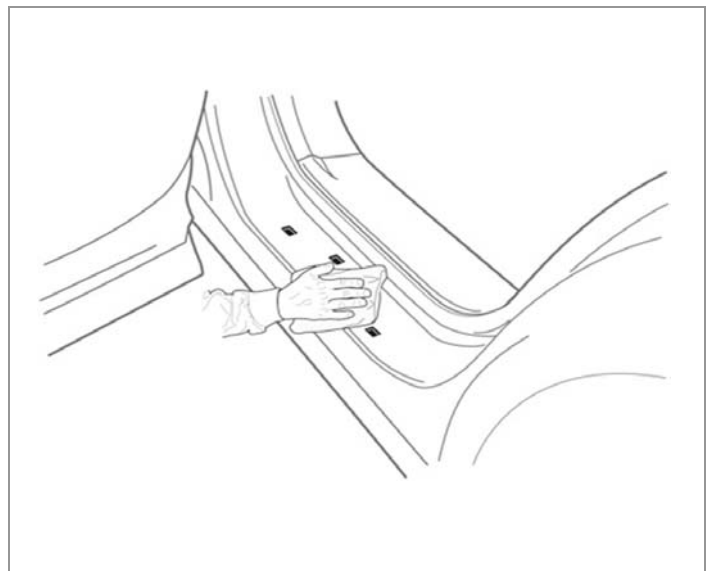
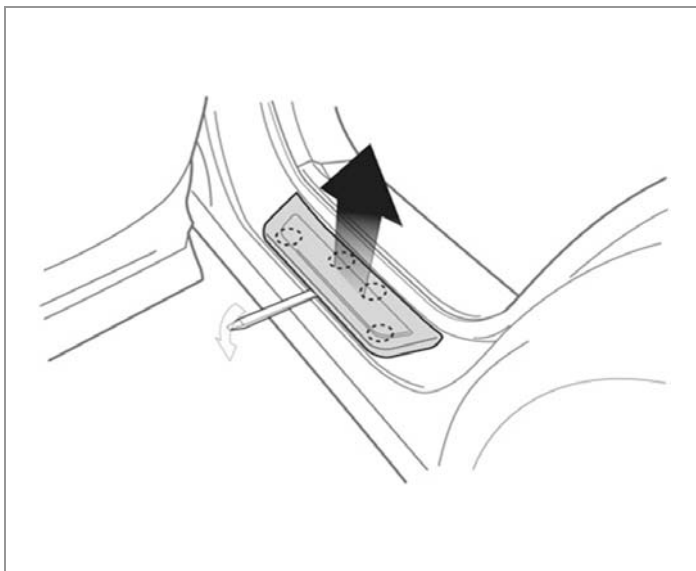

	6
N O T E	<ol style="list-style-type: none"> 1. Installation of the front door scuff plate is complete. 2. Repeat steps 1-5 for the right front (RF) door scuff plate (long) on the right hand (RH) side of the vehicle.



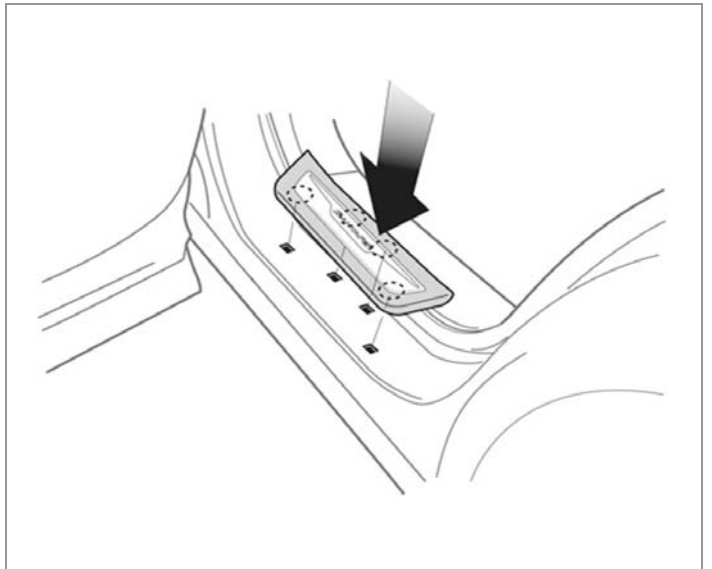
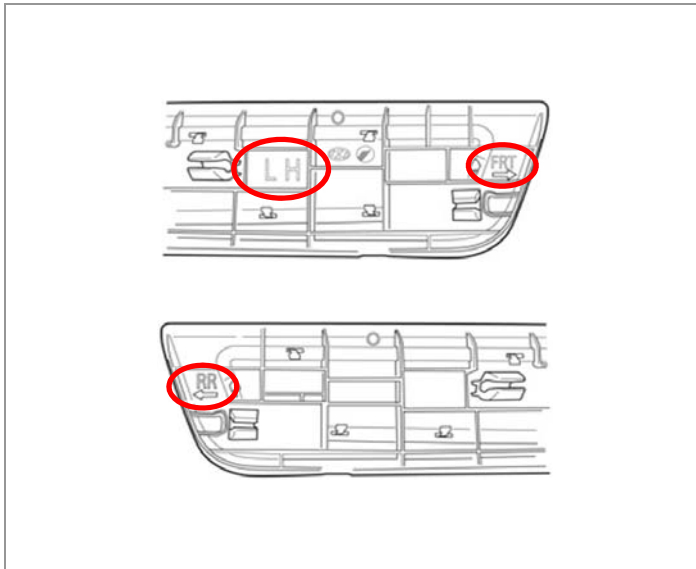

	Nylon Panel Removal Tool	7
N O T E	<ol style="list-style-type: none"> 1. Using a nylon panel removal tool, gently pull up to disengage the four (4) retention clips of the left rear (LR) OEM door scuff plate and remove from the side panel of the vehicle. 2. Discard the OEM door scuff plate. 	
	Do not scratch or damage the side panel when removing the OEM door scuff plate.	



	50/50 Isopropyl Alcohol (70%) & Water Mix and Lint Free Cloth	8
N O T E	<ol style="list-style-type: none"> 1. Using a 50/50 isopropyl alcohol (70%) & water mix and a lint free cloth, thoroughly clean the side panel as shown. 	

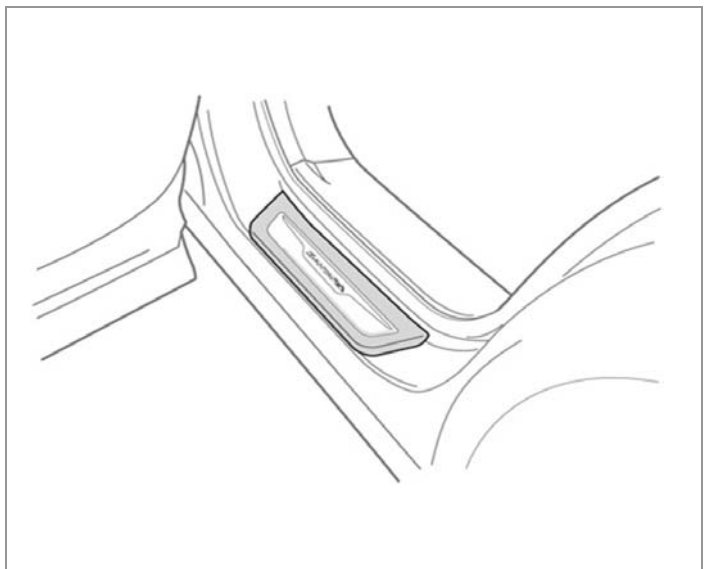
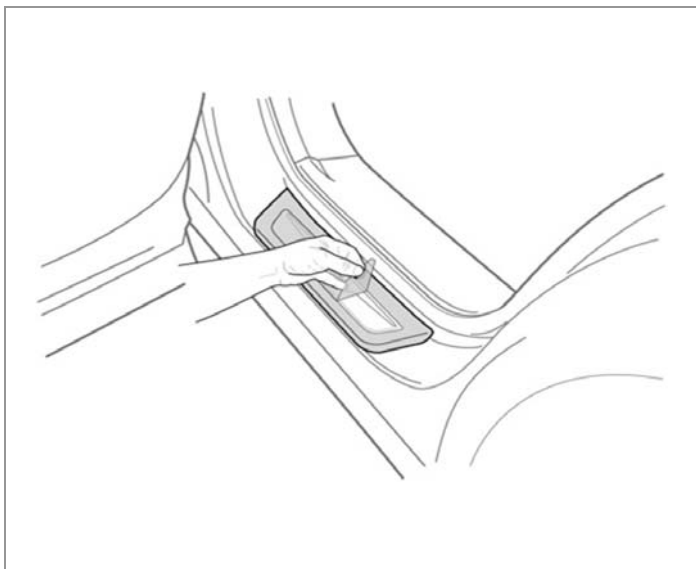

	9
NOTE	1. Identify the left rear (LR) door scuff plate (short) by the "LH" marking indicated on the backside as shown. 2. Orient the "FRT" and "RR" arrows of the door scuff plate with the front and rear of the vehicle.
	Make sure to correctly identify and orient the door scuff plate.

	10
NOTE	1. Align the four (4) clips of the left rear (LR) door scuff plate (short) to the four (4) rear left hand (LH) clip holes of the vehicle side panel as shown. 2. Gently push down on each of the four (4) clip locations to securely fasten the door scuff plate to the vehicle.
	Make sure all clips on the door scuff plate are fully inserted into the clip holes of the side panel.



	11
NOTE	1. Peel the protective film away from the left rear (LR) door scuff plate (short) as shown. 2. Discard the protective film.
	Do not scratch or damage the door scuff plate.

	12
NOTE	1. Installation of the rear door scuff plate complete. 2. Repeat steps 7-11 for the right rear (RR) door scuff plate (short) on the right hand (RH) side of the vehicle.

**HYUNDAI Genuine Accessories
Visual Check**

	Results of the check
	Door Sills are firmly attached to vehicle.
	Door sill clips are fully inserted into door sill holes.