



# HYUNDAI Genuine Accessories

Vehicle Model	Sonata	Accessory	Interior Lighting Kit
Model Year	2015 ~	Difficulty	( B )
Part No.	C2068 ADU01		

- Accessory Installation

**Note: Difficulty stated above reflects the minimum level of expertise required to install the accessory.**

### Application Notes

**Note: For 2018~ Sonata, the 25-Pin connector in step 17 has changed to a 36-Pin connector. Refer to page 9 for new T-Tap locations.**

### Instructional Symbols / Definitions

	Denotes warnings that may lead to serious physical injury or vehicle damage.		Denotes quality processes to be checked prior to moving to the next step.	Denotes safety equipment required to be used such as a mask, safety glasses, gloves, and hearing protection.	
	Denotes cautions to be taken to avoid physical injury or electronic component damage.		Denotes specific tools that are necessary to complete the step.		
	Denotes cautions to be taken to avoid vehicle and component damage.		Denotes instructional steps necessary to complete the process.		
				Mask	Safety Glasses
				Gloves	Hearing Protection

### Basic Required Hand Tools

				<b>FMVSS 110 Compliance Information</b>  <b>Part Number: C2068 ADU01</b>  <b>0.44 lbs</b> <b>0.2 kg</b> <b>(Gross Weight)</b>	All dealers must determine if the weight they have added in the form of all options or accessories, when added to the weight of all Port/Dealer Installed options or accessories, exceeds the lesser of 1.5% of GVWR or 100 lbs. If the additional weight does exceed the lesser of the indicated thresholds, a "Load Carrying Capacity Reduced" label must be installed. A black, fine-point, indelible marker must be used to write by hand onto the label, the reduced carrying capacity in kilograms or pounds, which is the total weight of all added options and accessories. Load Label Part Number: NP070 - 09003

**Hyundai Dealer Technical Support**

For Authorized Dealers – (800) 325-6604

Hours: M-F 8:00am – 8:00pm EST  
SAT 9:00am – 6:00pm EST

### Notes to the Installer:

- 1) Read the entire installation instructions prior to beginning the installation of this accessory.
- 2) Make sure the vehicle is completely clean before the accessory is installed.
- 3) Ensure the vehicle is properly protected in the area(s) that the accessory is to be installed.
- 4) To prevent vehicle damage, never place tools on top of painted surfaces, seats, dash pad, console or floor carpet/mats.
- 5) Always wear appropriate safety gear to include gloves and safety glasses when required.
- 6) Factory wire colors are subject to change, please use the specified pin # in the harness connector to identify the correct wire for T-Tap installation.





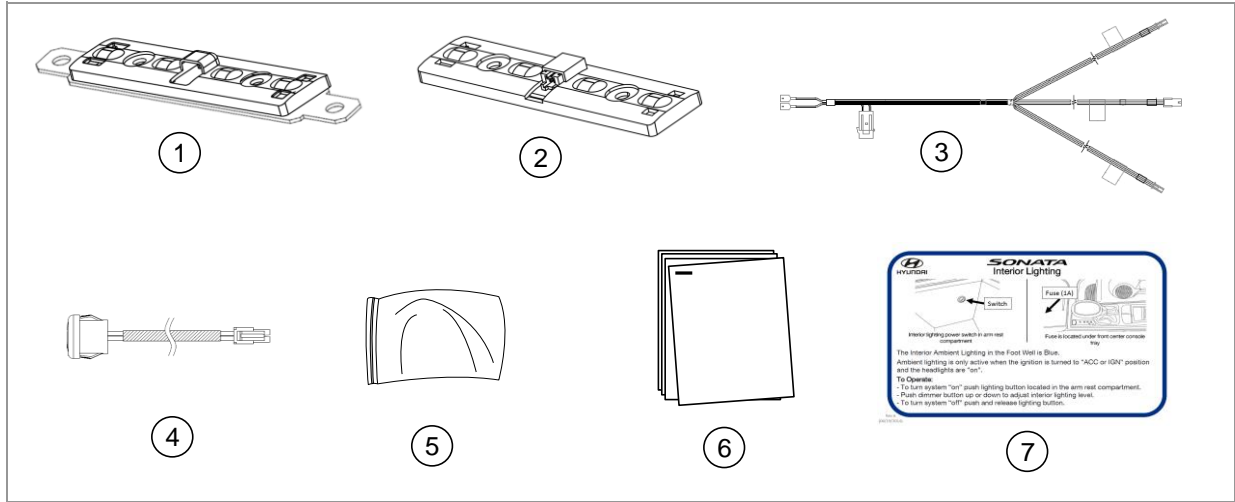

## HYUNDAI Genuine Accessories

### Kit Overview

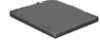

No.	Qty.	Description
1	1	LED & Bracket Assembly
2	1	LED
3	1	Wire Harness
4	1	Switch
5	1	Hardware Bag
6	1	Instruction Manual
7	1	Glove Box Information Card

### Hardware Overview

<b>A</b>		<b>B</b>		<b>C*</b>		<b>D</b>		<b>Hardware Total</b>
2	M6 x 12mm Bolt	2	M6 Nut	20	Wire Ties	2	Red T-Tap	
<b>E</b>		<b>F</b>						
3	Foam Tape	2	Plastic Fastener					

\* Extra components intentionally placed in kit as spares.  
Please follow directions for proper placement of each component.

**T-Tap Installation Procedure**

Factory wire harness colors are subject to change, please use the specified pin # in the harness connector to identify the correct wire for T-Tap installation.

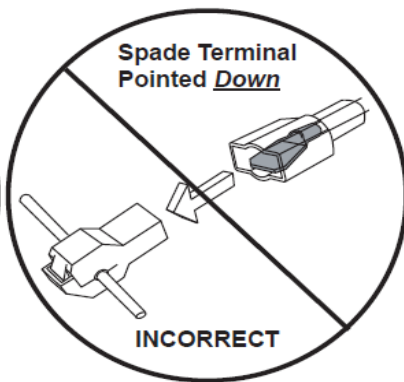
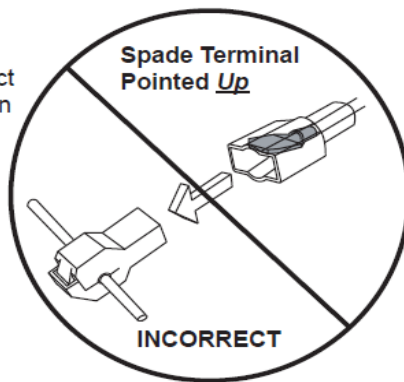

1. Place T-Tap on vehicle wire.

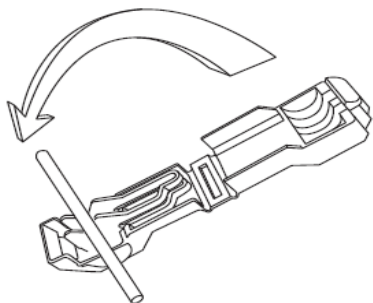

2. Using pliers, close and crimp T-Tap around vehicle wire.

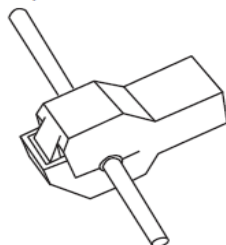

**CORRECT**  
Spade Terminal CENTERED  
Inside Connector

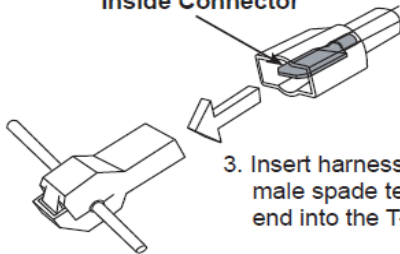

3. Insert harness wire with male spade terminal end into the T-Tap.

**\*\* Extreme care must be taken to ensure that the male spade terminal is inserted into the T-Tap properly.**

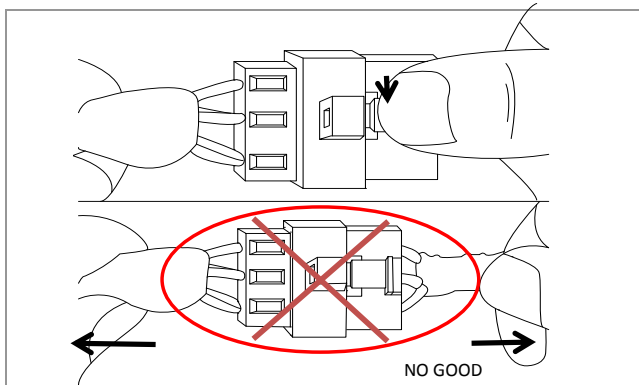

Disconnecting Connectors

When disconnecting connectors, press the lock tab and pull apart by grasping the connectors. **DO NOT PULL ON WIRES.**

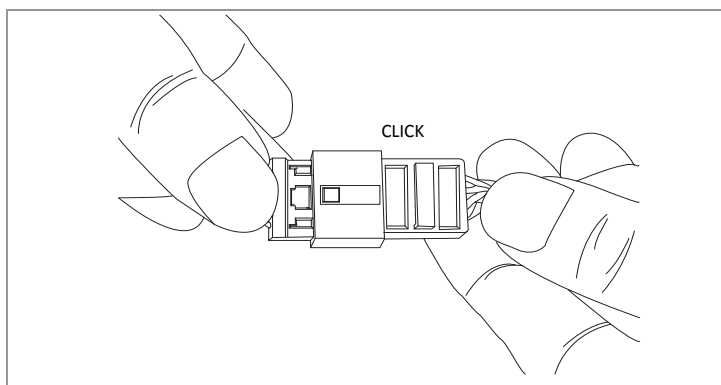

Lock Connectors

When locking connectors, listen for a click indicating they are securely locked.

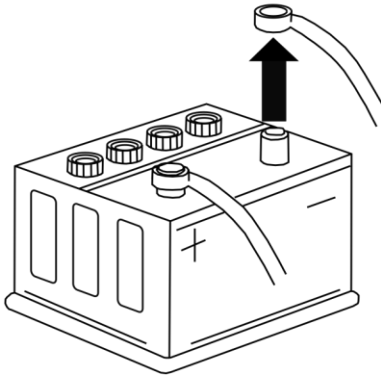

**Ratchet and 10mm Socket**

**1**

NOTE

1. Park the vehicle on a level surface.
2. Engage the Parking Brake.
3. Move the Gear Selector from Park (P) position to Drive (D) position.
4. Record all pre-set radio stations (if applicable).
5. Disconnect and isolate the vehicle's Negative Battery Cable.



**WARNING! Shock Hazard. Do not touch vehicle's negative battery terminal to vehicle's positive battery terminal. Serious physical injury or vehicle damage may occur.**

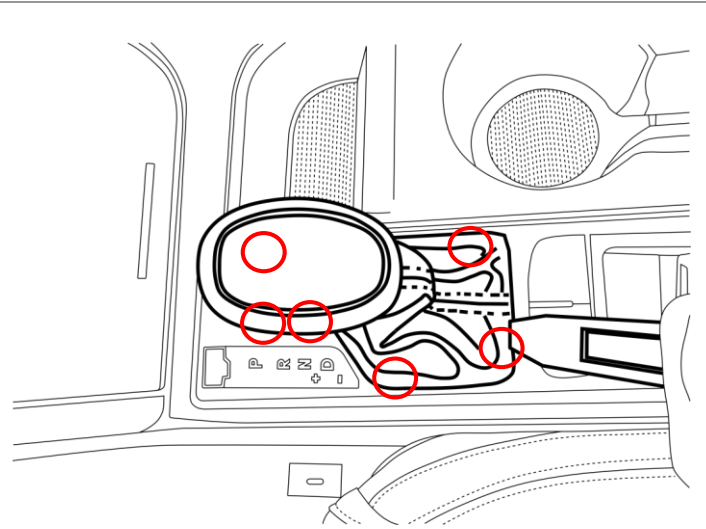

**Nylon Trim Panel Removal Tool**

**2**

NOTE

1. Using a Nylon Trim Panel Removal Tool, carefully release the six (6) clips surrounding the Shifter Boot.



**Caution: DO NOT scratch the Trim Panels or Shifter Boot.**

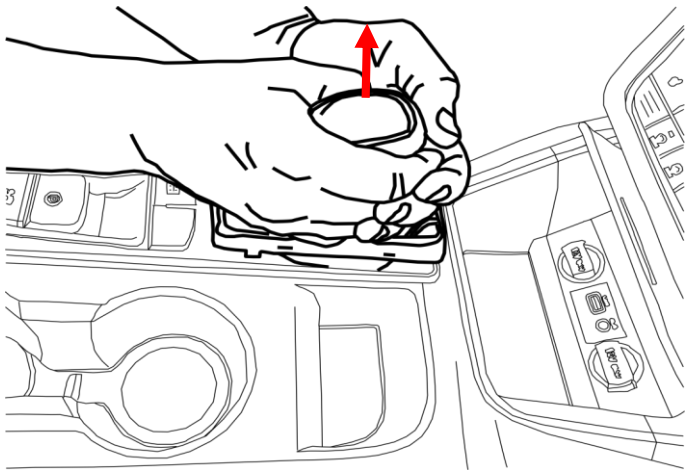

**3**

NOTE

1. Pull the Shift Knob up to remove the Shift Knob Assembly.
2. Store the Shift Knob Assembly in a safe location for reinstallation.



**Caution: DO NOT scratch the Trim Panels or Shift Knob Assembly.**

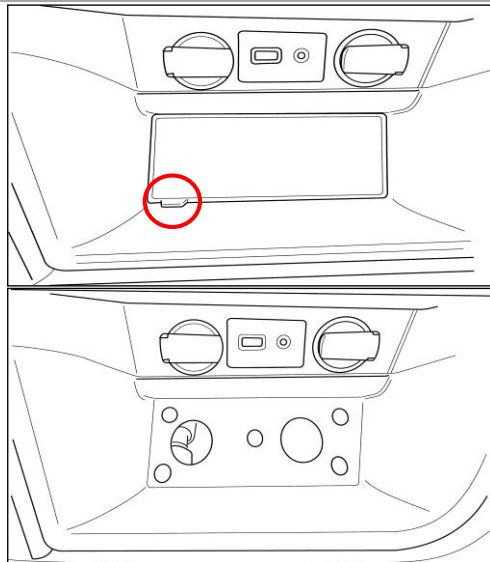

**4**



NOTE

- 2015 ~ 2017 Models Only:**
1. Open the Forward Tray Cover.
  2. Remove the Forward Tray Assembly:
    - Pull the Tab to remove the Rear Cover from the Forward Tray.
    - By hand, grasp the rear of the Forward Tray Assembly, then pull outward to remove.
  3. Store the Forward Tray Assembly in a safe location for reinstallation.



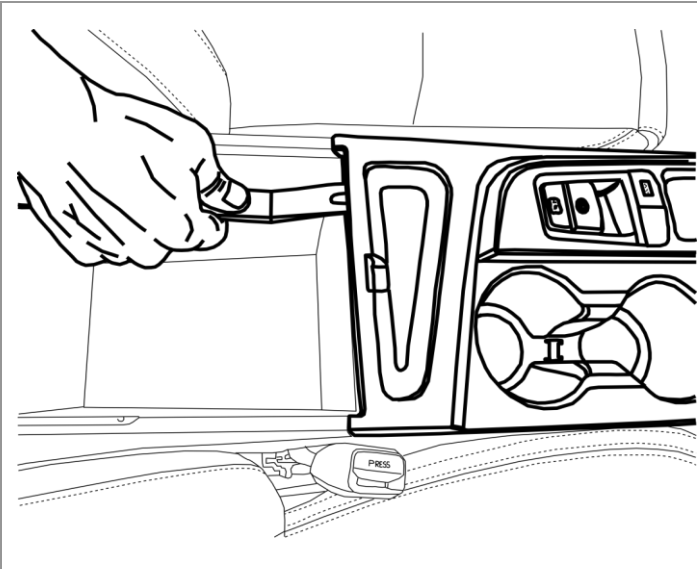

**Caution: DO NOT scratch the Center Console Panels or Forward Tray Assembly.**



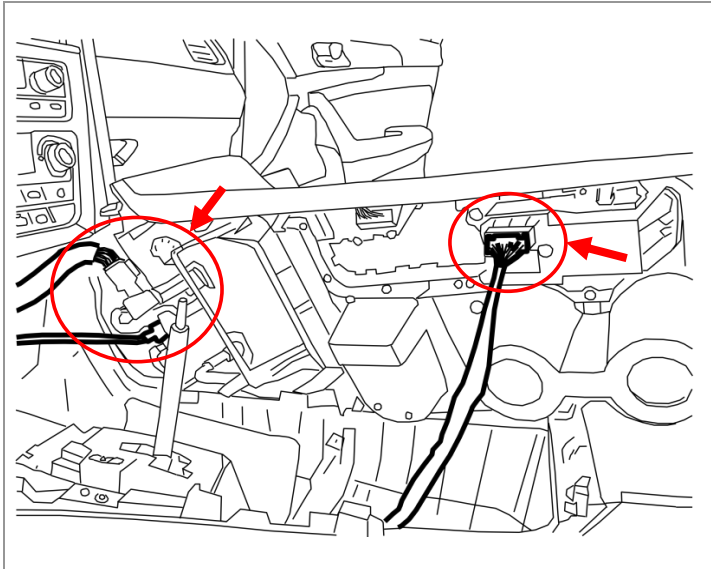

	<b>Nylon Trim Panel Removal Tool</b>	<b>5</b>
<b>NOTE</b>	<ol style="list-style-type: none"> <li>1. Lift the Center Arm Rest Cover to the open position.</li> <li>2. Close the Forward Tray Cover.</li> <li>3. Using a Nylon Trim Panel Removal Tool, dislodge the Center Console Cover.</li> </ol>	
	<b>Caution: DO NOT scratch the Trim Panels. DO NOT lose the eight (8) pressure clips.</b>	



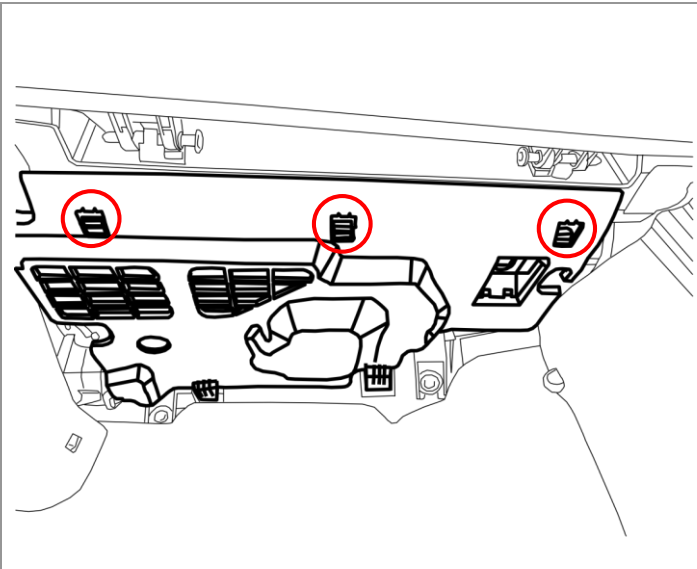

		<b>6</b>
<b>NOTE</b>	<ol style="list-style-type: none"> <li>1. Disconnect the Electrical Connectors from under the Center Console Cover.</li> <li>2. Store the Center Console Cover in a safe location for reinstallation.</li> </ol>	
	<b>Caution: DO NOT scratch the Center Console Cover.</b>	



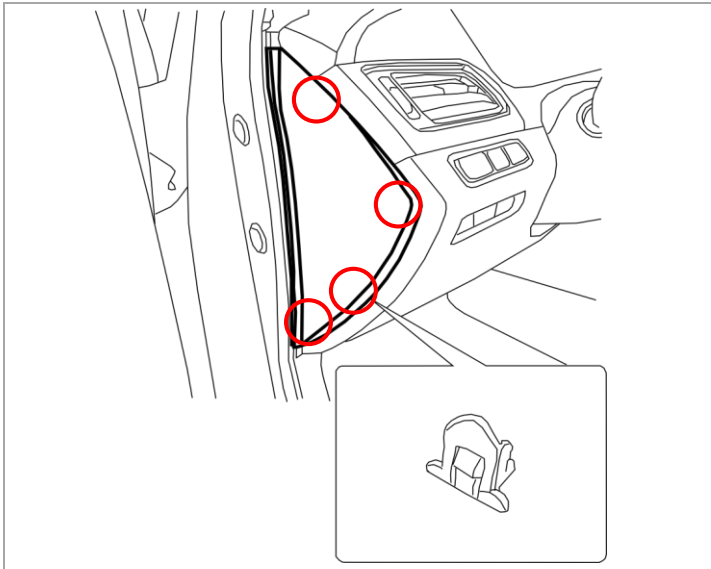

	<b>Nylon Trim Panel Removal Tool</b>	<b>7</b>
<b>NOTE</b>	<ol style="list-style-type: none"> <li>1. Remove the passenger side Close Out Panel by pressing the three (3) tabs rearward.</li> <li>2. Store the Close Out Panel in a safe location for reinstallation.</li> </ol>	
	<b>Caution: DO NOT scratch the Close Out Panel or surrounding Trim Panels.</b>	

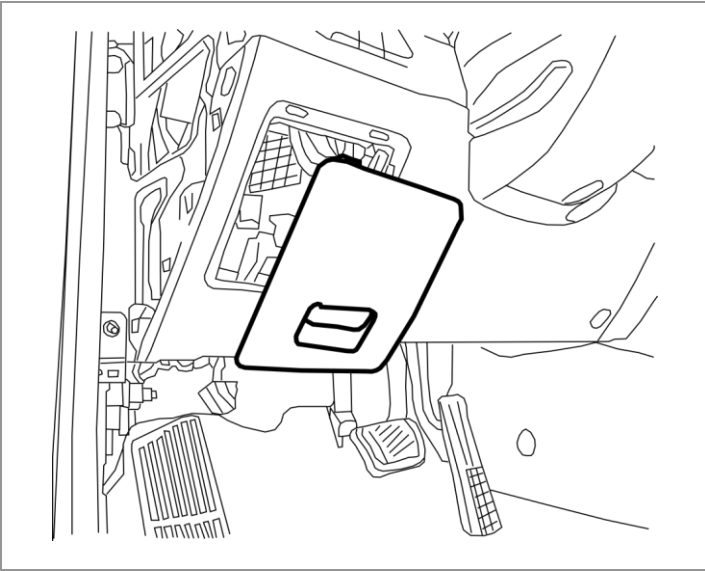

	<b>Nylon Trim Panel Removal Tool</b>	<b>8</b>
<b>NOTE</b>	<ol style="list-style-type: none"> <li>1. Remove the driver side Crash Pad Side Cover by releasing the four (4) clips as shown.</li> <li>2. Store the Crash Pad Side Cover in a safe location for reinstallation.</li> </ol>	
	<b>Caution: DO NOT scratch the Crash Pad Side Cover or surrounding Trim Panels.</b>	



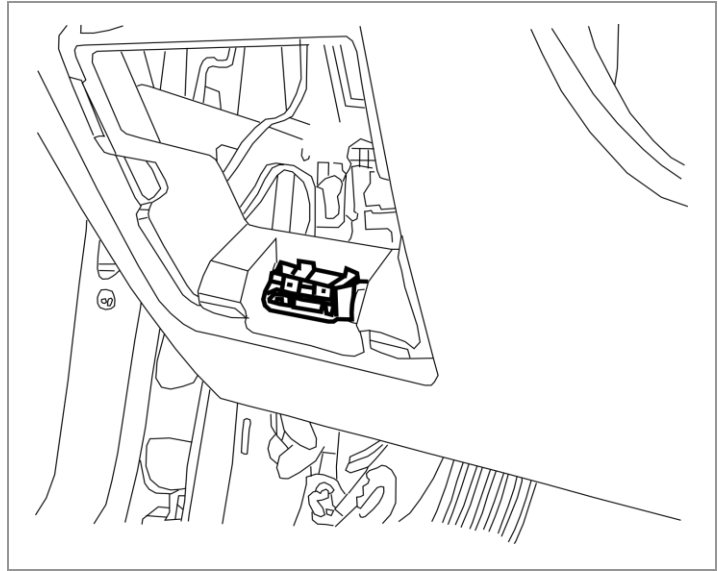

	9
NOTE	<ol style="list-style-type: none"> <li>1. By hand, remove the Fuse Cover.</li> <li>2. Store the Fuse Cover in a safe location for reinstallation.</li> </ol>
	<p>Caution: DO NOT scratch the Fuse Cover.</p>



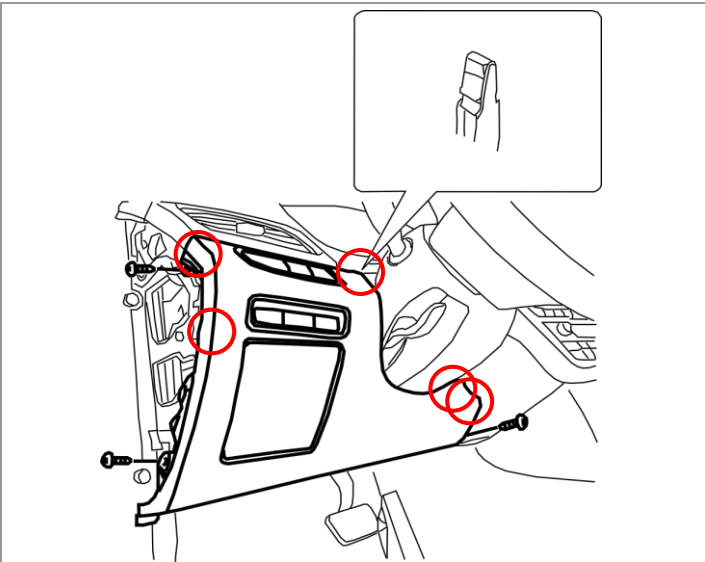

	Nylon Trim Panel Removal Tool	10
NOTE	<ol style="list-style-type: none"> <li>1. Disconnect the OBD Connector from the Lower Dash Panel.</li> </ol>	



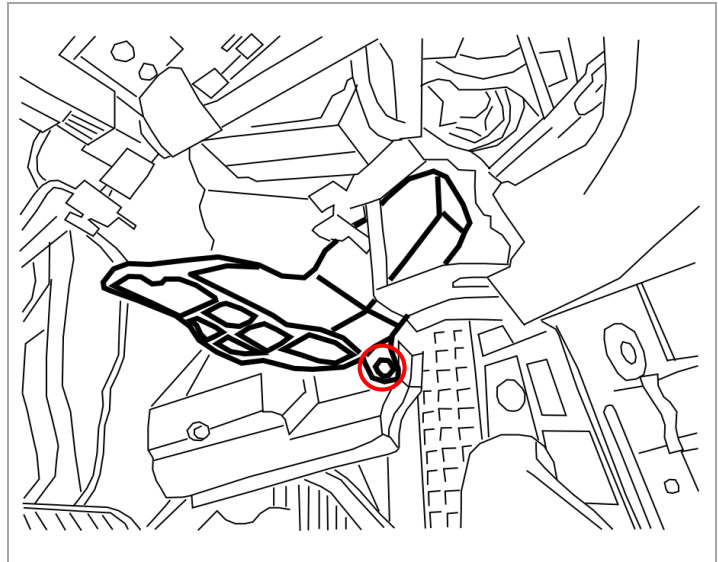

	Nylon Trim Panel Removal Tool, #2 Phillips Screwdriver	11
NOTE	<ol style="list-style-type: none"> <li>1. Remove the three (3) phillips screws.</li> <li>2. Remove the Lower Dash Panel by releasing the five (5) pressure clips.</li> <li>3. Store the Lower Dash Panel in a safe location for reinstallation.</li> </ol>	
	<p>Caution: DO NOT scratch the Lower Dash Panel. DO NOT lose the five (5) pressure clips or three (3) screws.</p>	



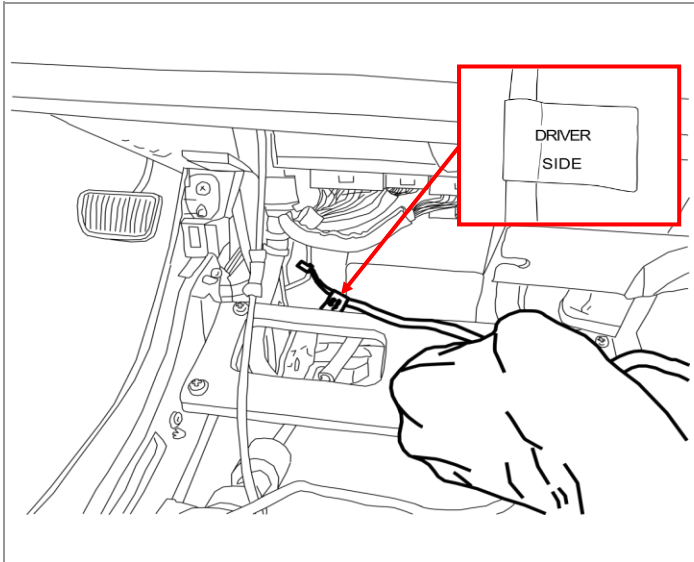

	#2 Phillips Screwdriver	12
NOTE	<p><b>2015 ~ 2017 Models Only:</b></p> <ol style="list-style-type: none"> <li>1. Remove the one (1) phillips screw.</li> <li>2. By hand, remove the driver side Foot Well HVAC Duct.</li> <li>3. Store the driver side Foot Well HVAC Duct in a safe location for reinstallation.</li> </ol>	
	<p>Caution: DO NOT lose the one (1) screws.</p>	





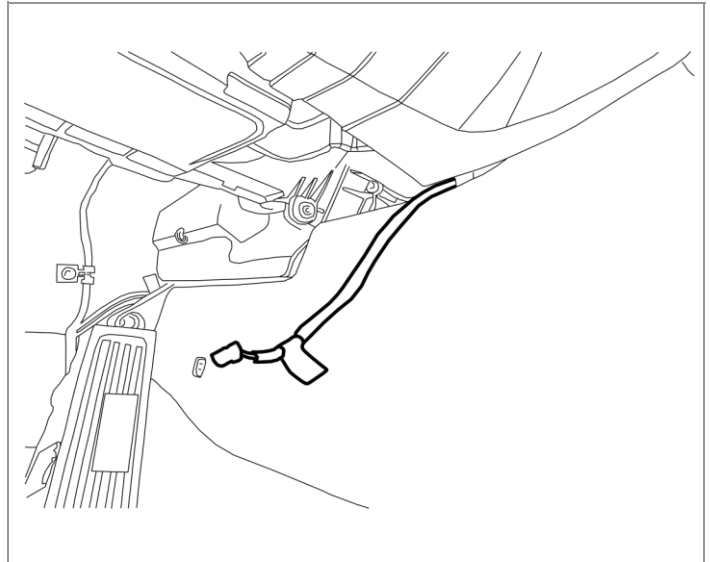

13	
NOTE	1. Route the Harness (Driver Side Label) through the front of the Center Console towards the Driver Side Footwell area.
	Caution: Make sure not to route the Harness near any sharp edges.

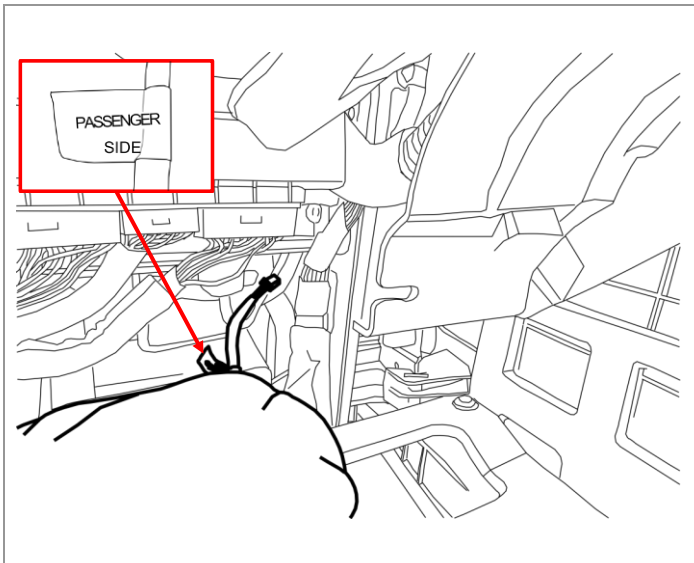

14	
NOTE	1. Pull the Harness (Driver Side Label) completely through to the Driver Side Footwell area as shown.
	Caution: Make sure not to route the Harness near any sharp edges.



15	
NOTE	1. Route the Harness (Passenger Side Label) through the front of the Center Console towards the Passenger Side Footwell area.
	Caution: Make sure not to route the Harness near any sharp edges.

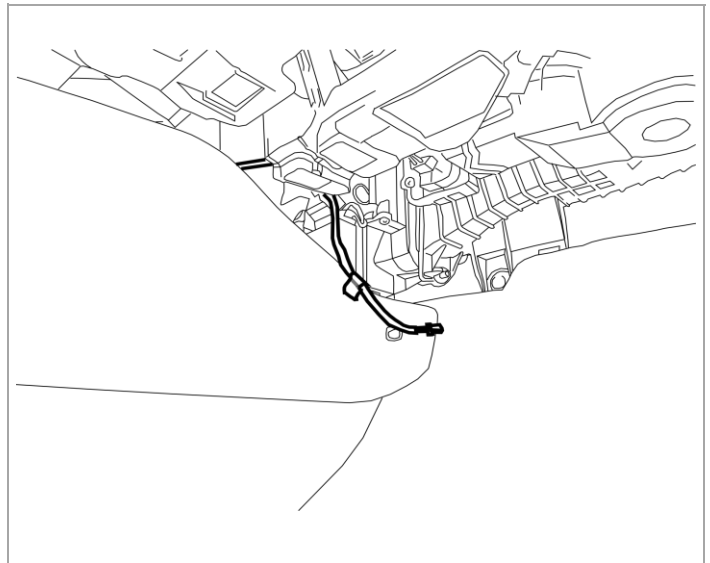

16	
NOTE	1. Pull the Harness (Passenger Side Label) completely through to the Passenger Side Footwell area as shown.
	Caution: Make sure not to route the Harness near any sharp edges.

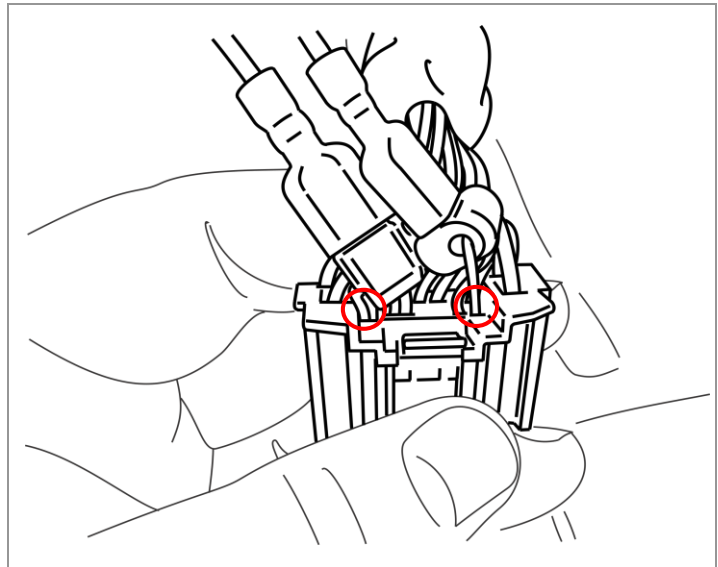
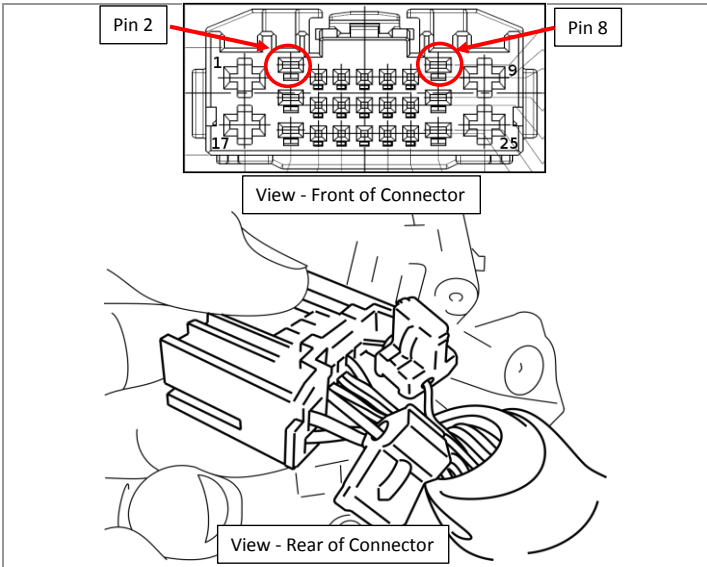

	<b>Pliers</b>	<b>17</b>
<b>NOTE</b>	<p><b>2015 ~ 2017 Models Only:</b></p> <ol style="list-style-type: none"> <li>At the Center Console area, locate the 25 Pin Connector #3. - Refer to step 6 on page 5.</li> <li>Connect one Red T-Tap to the Blue Wire at Pin #2 as shown. - Refer to the T-Tap Installation Procedure on page 3.</li> <li>Connect one Red T-Tap to the Gray Wire at Pin #8 as shown. - Refer to the T-Tap Installation Procedure on page 3.</li> </ol>	
	<p><b>Caution: Be sure to install the T-Taps on the correct vehicle wires.</b></p>	

		<b>18</b>
<b>NOTE</b>	<p><b>2015 ~ 2017 Models Only:</b></p> <ol style="list-style-type: none"> <li>Connect the Blue Wire from the Interior Light Harness to the Red T-Tap at Pin #2. - Refer to the T-Tap Installation Procedure on page 3.</li> <li>Connect the Gray Wire from the Interior Light Harness to the Red T-Tap at Pin #8. - Refer to the T-Tap Installation Procedure on page 3.</li> </ol>	
	<p><b>Caution: Make sure you connect the correct wire to the correct Red T-Tap. There may be several wires of the same / similar color.</b></p>	

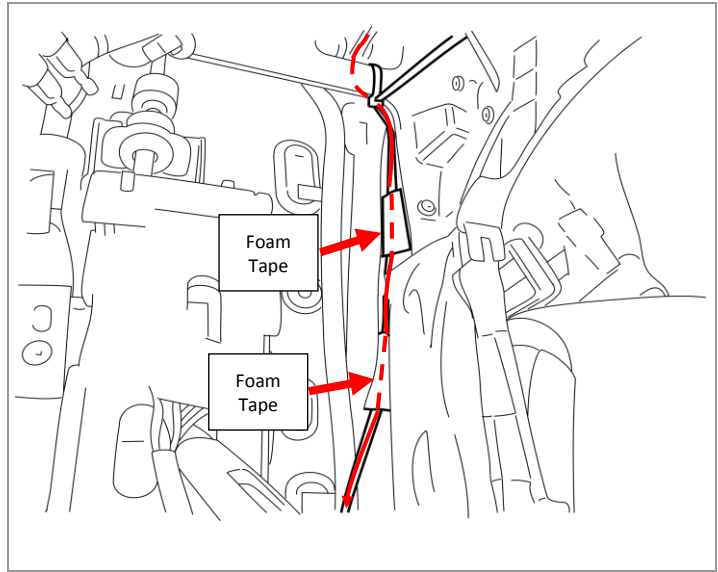
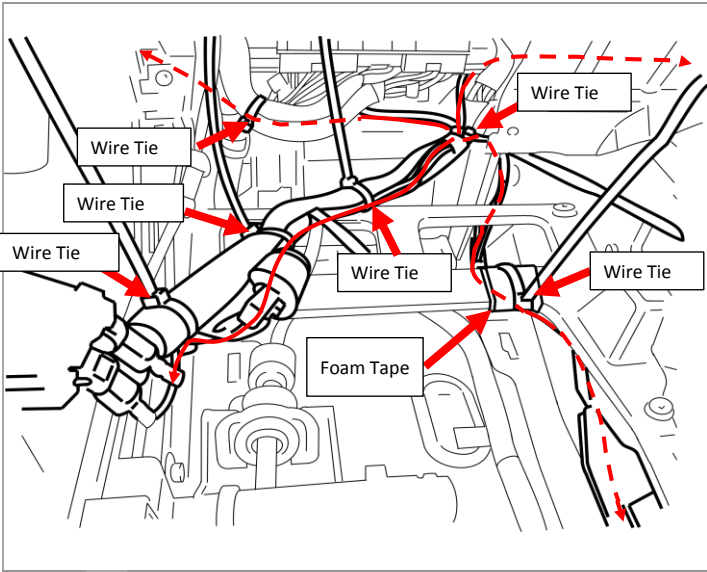

	<b>Wire Cutters and Scissors</b>	<b>19</b>
<b>NOTE</b>	<p><b>2015 ~ 2017 Models Only:</b> <b>Vehicles WITHOUT rear HVAC duct</b></p> <ol style="list-style-type: none"> <li>Route the Interior Light Harness, as shown.</li> <li>Apply one (1) piece of Foam Tape to the Cross Member as shown above (cut supplied Foam Tape in half).</li> <li>Use six (6) wire ties to secure the Interior Light Harness as shown.</li> <li>Trim excess wire tie material.</li> </ol>	
	<p><b>Caution: Make sure not to route the Harness near any sharp edges.</b></p>	

	<b>Scissors</b>	<b>20</b>
<b>NOTE</b>	<p><b>2015 ~ 2017 Models Only:</b> <b>Vehicles WITHOUT rear HVAC duct</b></p> <ol style="list-style-type: none"> <li>Using two (2) pieces of Foam Tape, secure the Interior Light Switch Harness as shown above (cut supplied foam tape in half).</li> </ol> <p><b>Note: Vehicles with rear HVAC follow the Interior Light Switch Harness routing shown in step 24.</b></p>	
	<p><b>Caution: Be sure not to route Interior Light Harness near any sharp edges.</b></p>	



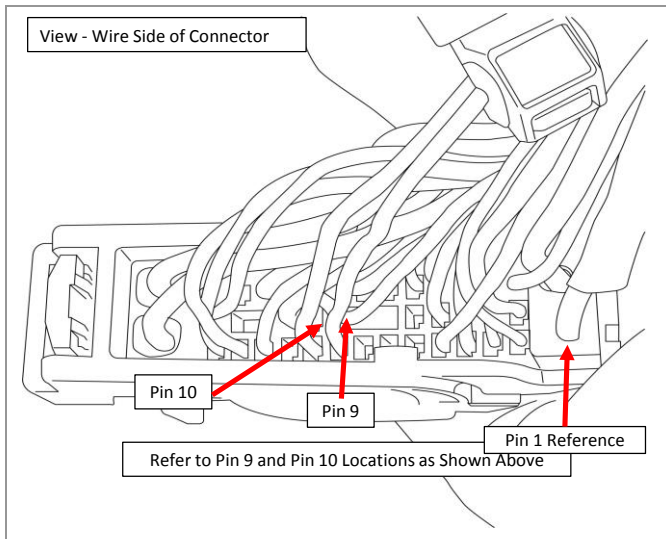

**Tools:** Pliers 21

**NOTE**

**2018 - Models Only:**

1. At the front of Center Console area, locate the 36 Pin Connector.
2. Connect one Red T-Tap to the Blue Wire at Pin #9 as shown in step 22.
3. Connect one Red T-Tap to the Gray Wire at Pin #10 as shown in step 22.

- Refer to the T-Tap Installation Procedure on page 3.

**Caution:** Be sure to install the T-Taps on the correct vehicle wires. There are several wires of the same / similar color.

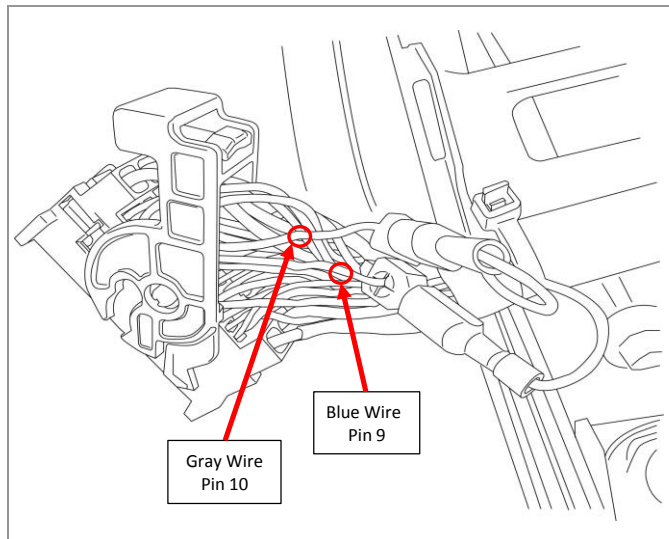

**Tools:** 22

**NOTE**

**2018 - Models Only:**

1. Connect the Blue Wire from the Interior Light Harness to the Red T-Tap at Pin #9, Blue Wire.
2. Connect the Gray Wire from the Interior Light Harness to the Red T-Tap at Pin #10, Gray Wire.

- Refer to the T-Tap Installation Procedure on page 3.

**Caution:** Make sure you connect the correct wire to the correct Red T-Tap.

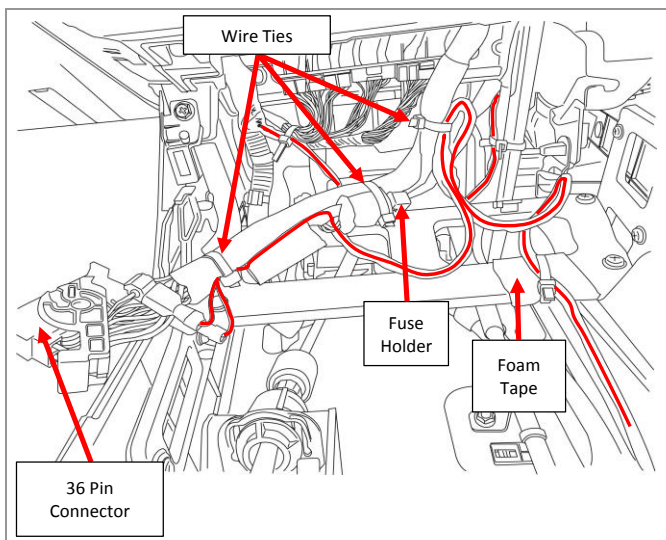

**Tools:** Wire Cutters and Scissors 23

**NOTE**

**2018 - Models Only:**

1. Route the Interior Light Harness, as shown.
2. Secure the Interior Light Harness to the factory harness as shown, using two (2) wire ties.
3. Secure the Fuse Holder to the factory harness as shown, using one (1) wire tie.
4. Cut one (1) piece of Foam Tape in half and apply one (1) half over the crossmember as shown above.
5. Secure the Interior Light Switch Harness over the Foam Tape on the crossmember using one (1) wire tie, as shown above.
6. Trim excess wire tie material.

**Caution:** Make sure not to route the Harness near any sharp edges.

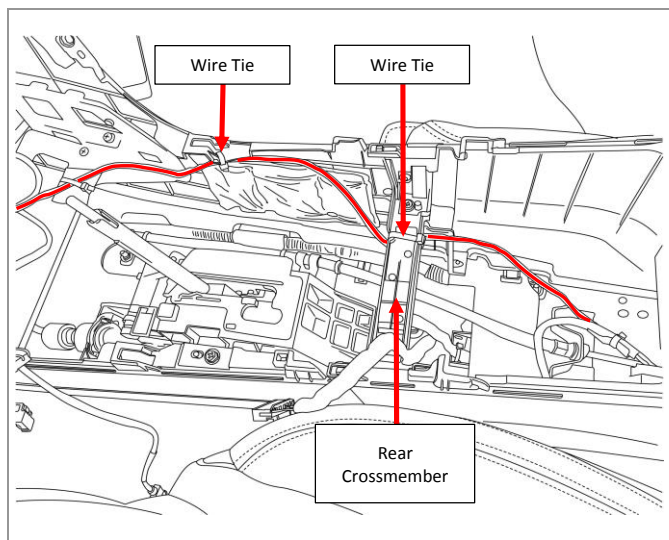

**Tools:** Wire Cutters 24

**NOTE**

**All Models:**

1. Using one (1) wire tie, secure the Interior Light Switch Harness to the rear of the pressure clip hole on side panel, as shown.
2. Using one (1) wire tie, secure the Interior Light Switch Harness to the underside of the Rear Crossmember as shown.
3. Trim excess wire tie material.

**Caution:** Be sure not to route Interior Light Harness near any sharp edges.

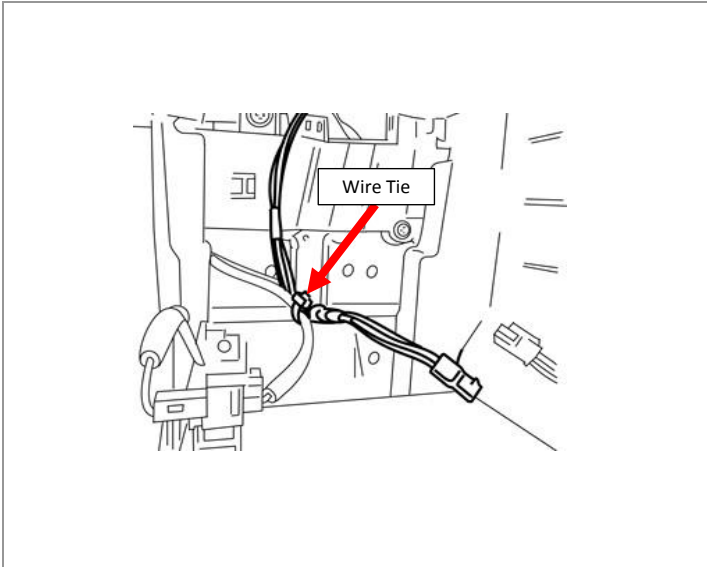

	<b>Wire Cutters</b>	<b>25</b>
<b>NOTE</b>	<ol style="list-style-type: none"> <li>Using one (1) wire tie, secure the Interior Light Switch Harness to the factory Accessory Harness as shown.</li> <li>Trim excess wire tie material.</li> </ol>	
	<b>Caution: Be sure not to route Interior Light Harness near any sharp edges.</b>	

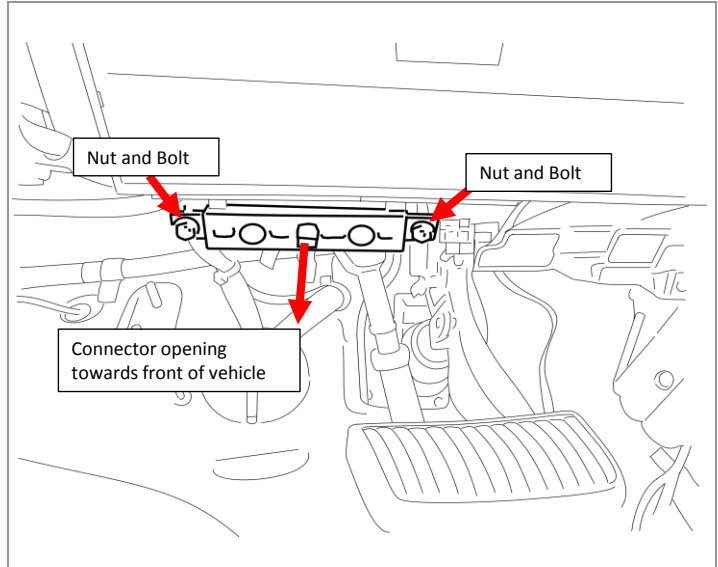

	<b>Ratchet, 10mm Socket, 10mm Wrench and Torque Wrench</b>	<b>26</b>
<b>NOTE</b>	<ol style="list-style-type: none"> <li>Using two (2) M6 Nuts and two (2) M6 Bolts, install the Driver Side LED Module Assembly onto the two (2) Steel Brackets located behind the Knee Air Bag.</li> <li>Orient the LED Module Connector Opening towards the front of the vehicle.</li> <li>Torque the M6 Nuts and M6 Bolts to 10.4 N.m (1 Kgf.m, 7.7 lb-ft).</li> </ol>	

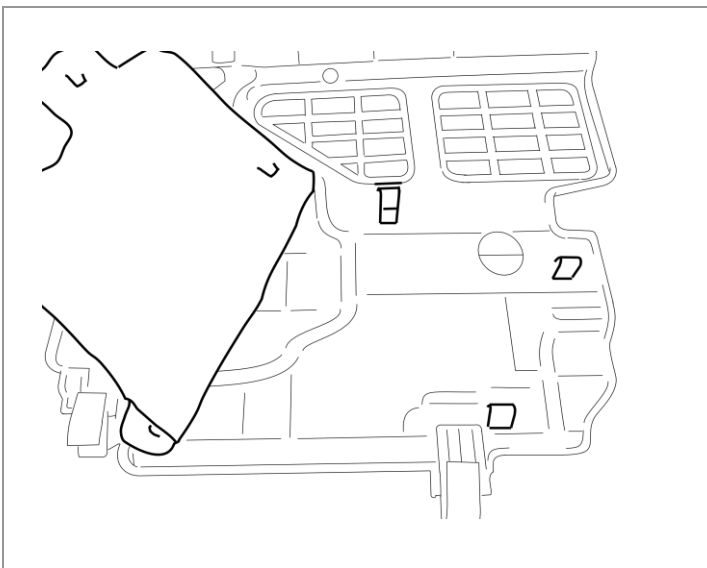

		<b>27</b>
<b>NOTE</b>	<ol style="list-style-type: none"> <li>Detach the Sound Dampening Material from the HVAC Close-Out Panel.</li> </ol>	

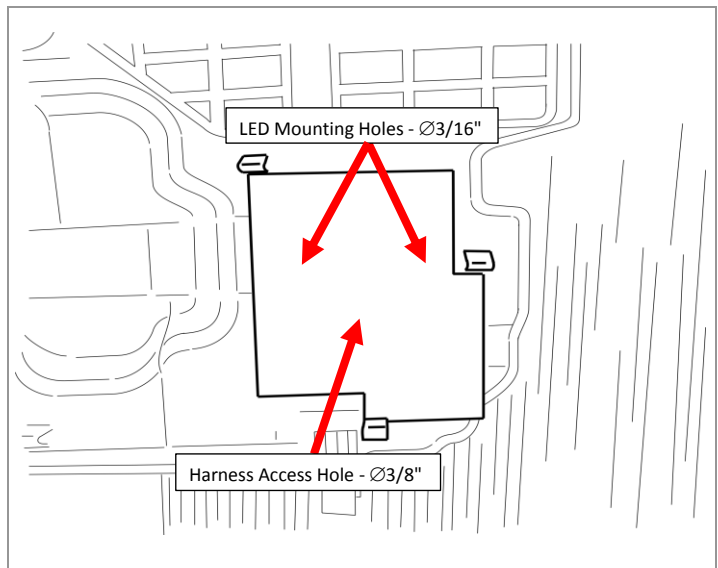

	<b>Scissors, Center Punch, Electric Drill, 3/16" Drill Bit, 3/8" Drill Bit and Deburring Tool</b>	<b>28</b>
<b>NOTE</b>	<ol style="list-style-type: none"> <li>Using a Scissors, cut out the LED Module Template.</li> <li>Place the Template on the Close Out Panel and mark the three (3) Mounting Holes using a Center Punch.</li> <li>Using an Electric Drill and 3/16" Drill Bit, drill the two (2) outer LED Module Mounting Holes.</li> <li>Using an Electric Drill and 3/8" Drill Bit, drill the one (1) Interior Light Harness Access Hole.</li> </ol>	
	<b>Be careful not to enlarge the holes while drilling and deburring.</b>	

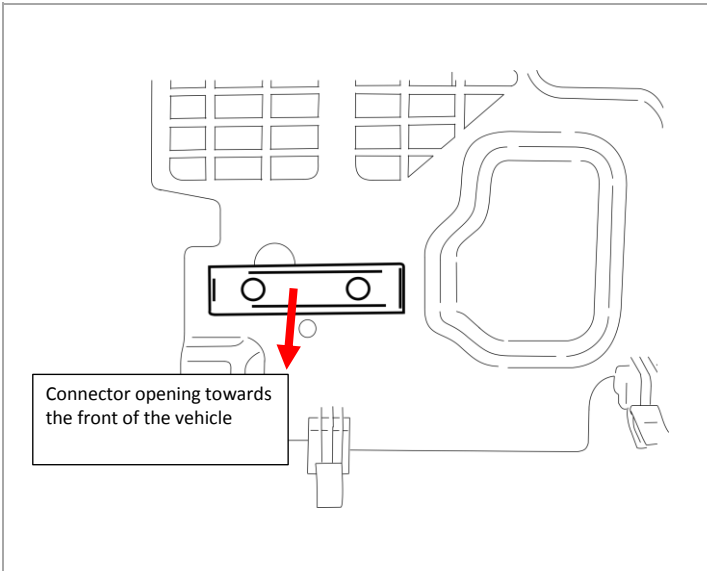

	29
NOTE	<ol style="list-style-type: none"> <li>1. Install the LED Module onto the Close Out Panel.</li> <li>2. Make sure the LED Module Connector Opening is facing the Interior Light Harness Access Hole.</li> <li>3. Store the HVAC Close Out Panel in a safe location for reinstallation.</li> </ol>

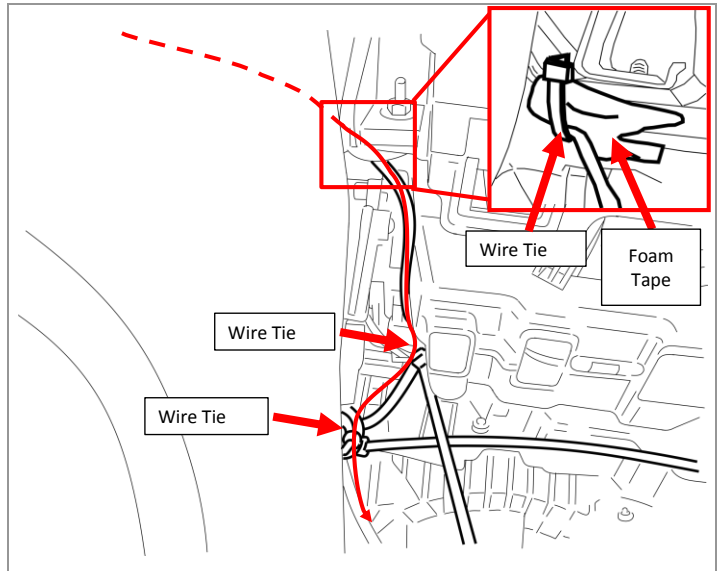

	30
NOTE	<p><b>Wire Cutters and Scissors</b></p> <ol style="list-style-type: none"> <li>1. From the Passenger Side Footwell, install one (1) Foam Tape on the Metal Bracket as shown above (cut supplied Foam Tape in half).</li> <li>2. Using three (3) wire ties, secure the Interior Light Harness to the Factory Harness as shown.</li> <li>3. Trim excess wire tie material.</li> </ol>
	<p><b>Caution:</b> Be sure not to route the Interior Light Harness near any sharp edges.</p>

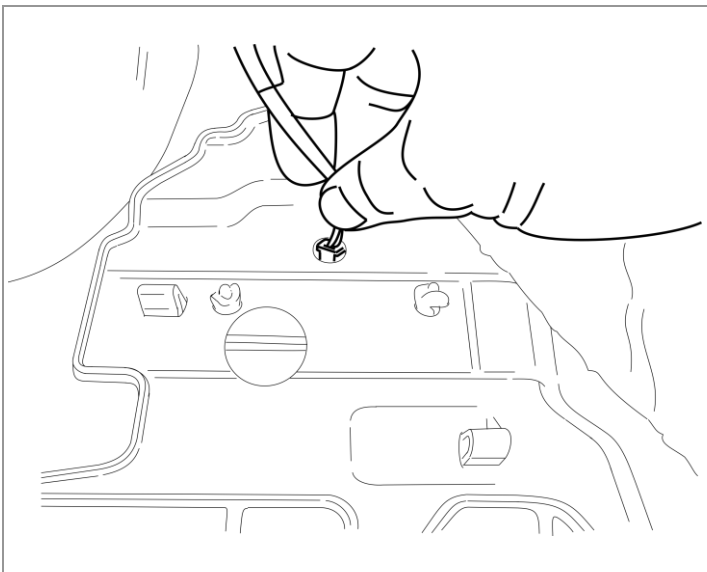

	31
NOTE	<ol style="list-style-type: none"> <li>1. Route the Passenger Side Interior Light Harness through the 3/8" Access Hole.</li> <li>2. Connect the Interior Light Harness to the LED Module.</li> <li>3. Adjust the Interior Light Harness to allow the HVAC Close Out Panel to be lowered for service access.</li> <li>4. Reinstall the Sound Dampening Material to the Close Out Panel.</li> </ol>

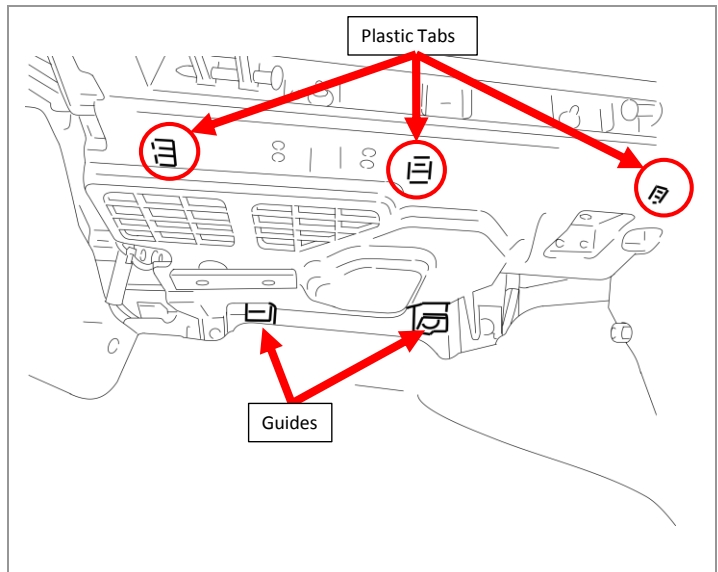

	32
NOTE	<ol style="list-style-type: none"> <li>1. Reinstall the Close Out Panel.                     <ul style="list-style-type: none"> <li>- Engage the two (2) Guides at the Bulkhead, then engage the three (3) Plastic Tabs as shown.</li> </ul> </li> </ol>

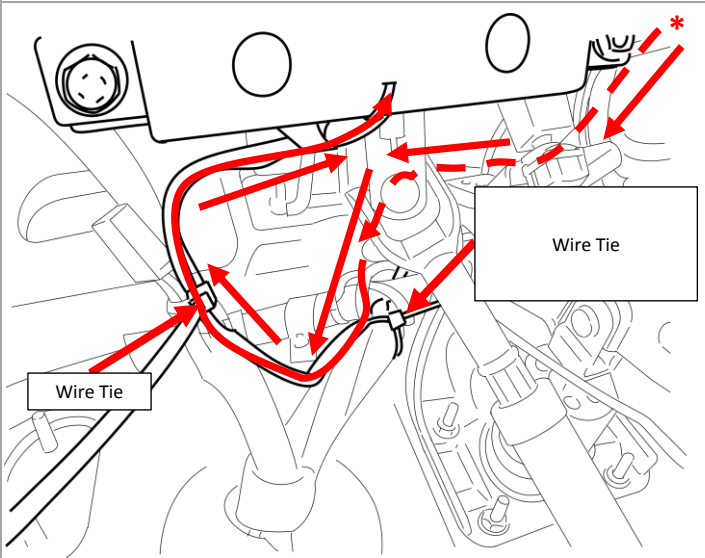

**Wire Cutters** 33

- NOTE**
- For 2018~ models, route driver side harness up between the HVAC duct (noted in step 12) and the HVAC housing, and then over to the area show by the asterisk (\*) above.
1. From the Driver Side Footwell, route the Driver Side Interior Light Harness over the Steering Column, then to the LED Module.
  2. Connect the Interior Light Harness to the LED Module.
  3. Using two (2) wire ties, secure the Driver Side Interior Light Harness to the Factory Harnesses as shown above.
  4. Trim excess wire tie material.

**Caution:** Be sure not to route the Interior Light Harness near any sharp edges or steering column.

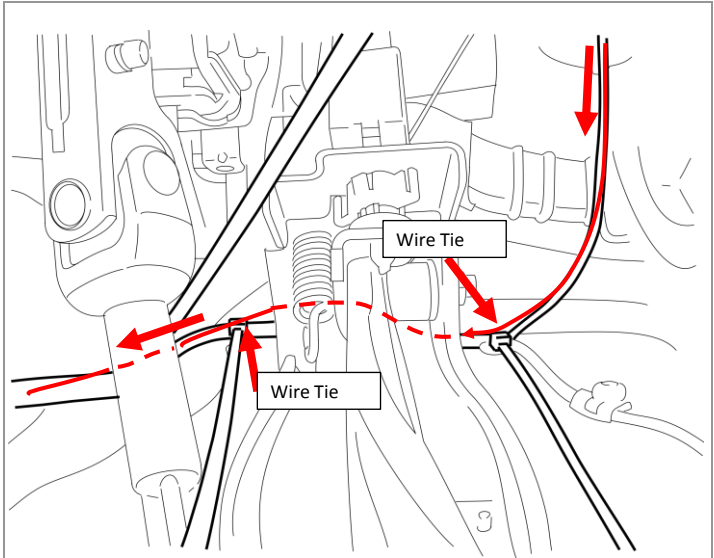

**Wire Cutters** 34

- NOTE**
1. Using two (2) wire ties, secure the Driver Side Interior Light Harness to the Factory Harness as shown above.
  2. Trim excess wire tie material.

**Caution:** Be sure not to route the Interior Light Harness near any sharp edges or Steering Column.

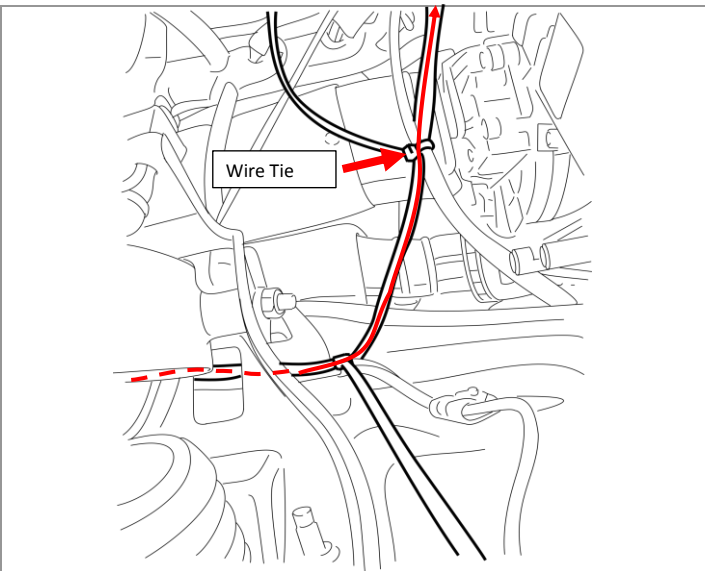

**Wire Cutters** 35

- NOTE**
1. Using one (1) wire tie, secure the Driver Side Interior Light Harness to the Factory Harnesses as shown.
  2. Trim excess wire tie material.

**Caution:** Be sure not to route the Interior Light Harness near any sharp edges.

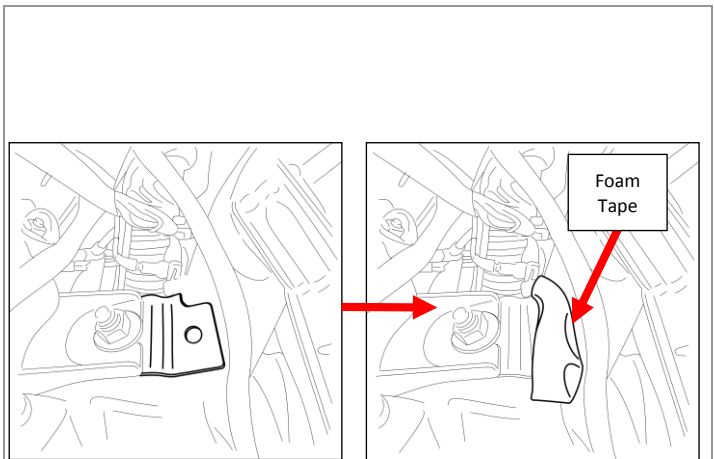

**Scissors** 36

- NOTE**
1. Install one (1) Foam Tape onto the Metal Bracket as shown (cut supplied Foam Tape in half).
- \* Metal Bracket is located above the Center Console Side Panel at the Driver Side Footwell area.





	<b>Wire Cutters</b>	<b>37</b>
<b>NOTE</b>	<ol style="list-style-type: none"> <li>1. Route the Driver Side Interior Light Harness over the Foam Tape (step 36), then secure to the Metal Bracket using one (1) wire tie.</li> <li>2. Trim excess wire tie material.</li> </ol>	
	<p><b>Caution:</b> Be sure not to route the Interior Light Harness near any sharp edges.</p>	

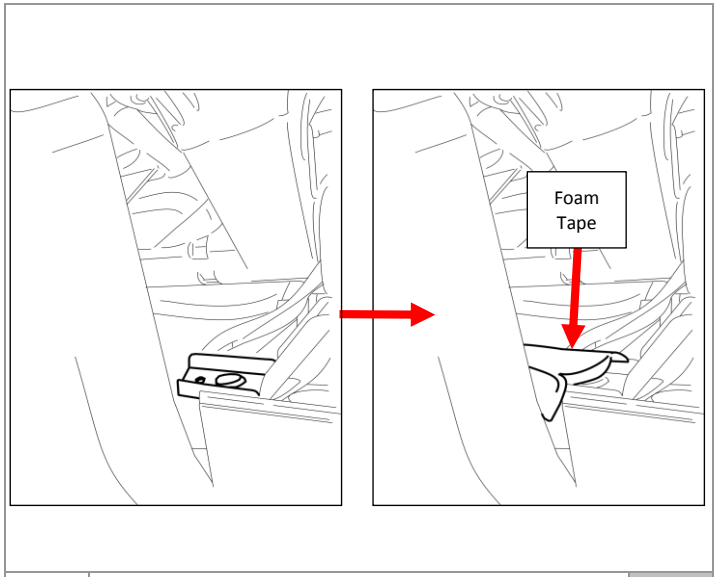

	<b>Scissors</b>	<b>38</b>
<b>NOTE</b>	<ol style="list-style-type: none"> <li>1. Install one (1) Foam Tape to the Metal Bracket as shown, to protect the Interior Light Harness (cut supplied Foam Tape in half).</li> </ol> <p>* Metal Bracket is located behind the Center Console near the Driver Side Interior Light Harness.</p>	

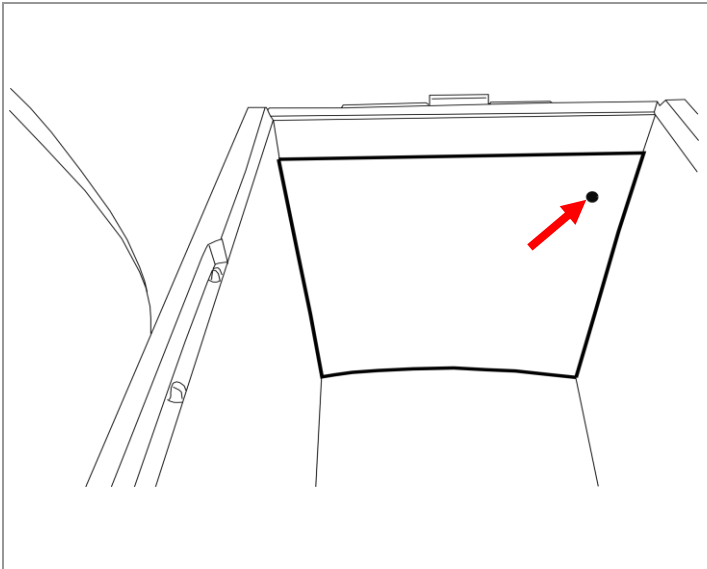

	<b>Scissors, Center Punch, Electric Drill and 3/16" Drill Bit</b>	<b>39</b>
<b>NOTE</b>	<ol style="list-style-type: none"> <li>1. Using a Scissors, cut out the Switch Template.</li> <li>2. Place the Template in the Center Armrest Compartment and mark the hole using a Center Punch.</li> <li>3. From the other side of Center Armrest Compartment, use the center punch again on the dimple made in note 2, to allow drilling on this side.</li> <li>4. Using an Electric Drill and 3/16" Drill bit, drill a pilot hole.</li> </ol>	

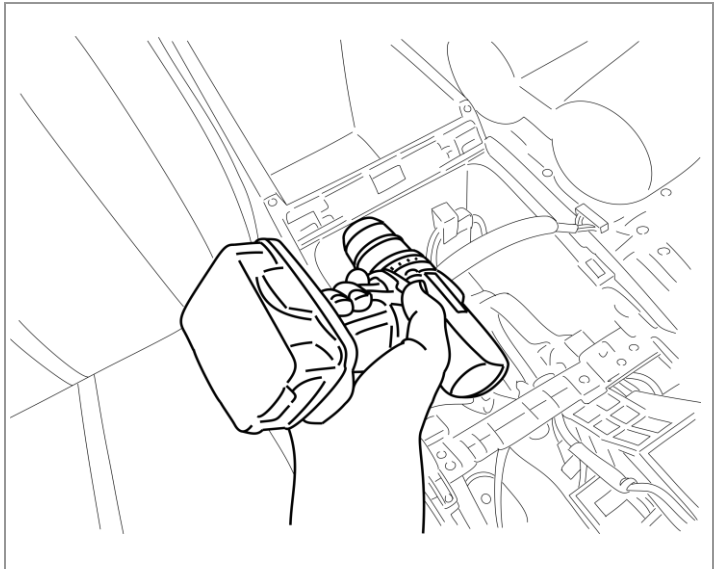

	<b>Electric Drill and 19/32" Drill Bit, Deburring Tool</b>	<b>40</b>
<b>NOTE</b>	<ol style="list-style-type: none"> <li>1. Using an Electric Drill and 19/32 Drill Bit, drill the hole.</li> <li>2. Deburr the hole using a Deburring Tool.</li> </ol> <p><b>Be careful not to enlarge the hole while drilling and deburring, otherwise the switch will be too loose in the drilled hole.</b></p>	



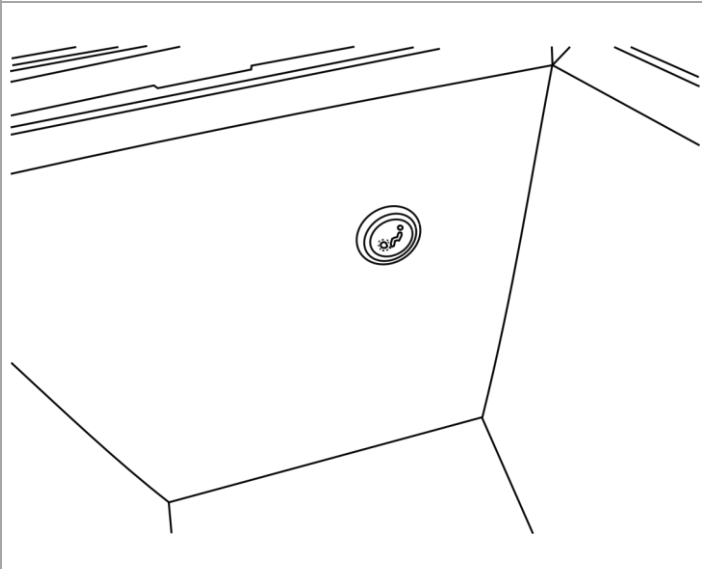

41
NOTE
<p>1. Insert the Switch into the hole.                  - Make sure the Switch snaps in tightly and is oriented correctly as shown.</p>

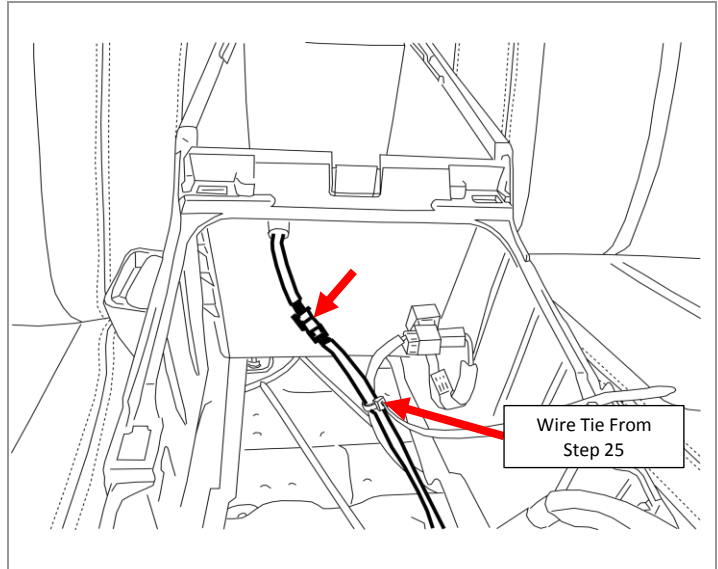



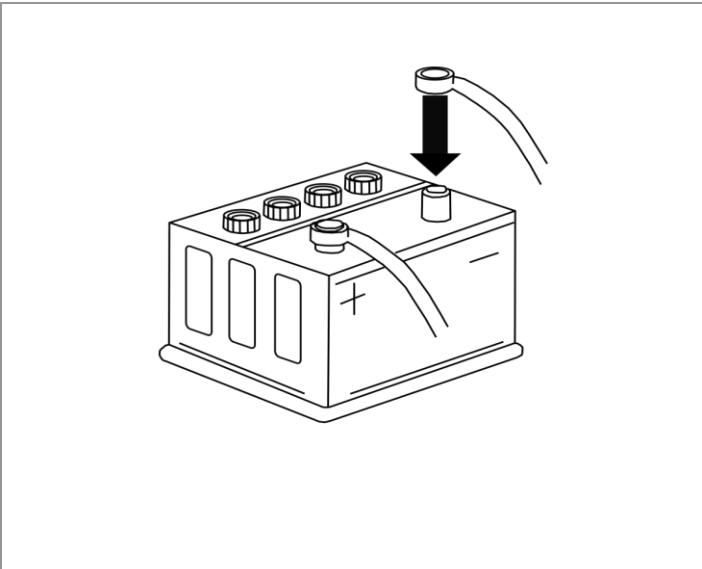



42
NOTE
<p>1. Connect the Interior Light Harness Connector to the Switch as shown.</p>
<p><b>CAUTION:</b> Make sure the connector is fully seated and locked into place.</p>



43
NOTE
<p>1. Reassemble all removed components in reverse order of removal.                  2. Place the Owner's Information Card in the glove box.                  3. Reconnect the vehicle's Negative Battery Cable.                  4. Program radio pre-sets recorded in step 1 (if applicable).</p>
<p><b>WARNING!</b> Shock Hazard. Do not touch vehicle's negative battery terminal to vehicle's positive battery terminal. Serious physical injury or vehicle damage may occur.</p>



## HYUNDAI Genuine Accessories Function Check

Items To Be Checked	Results Of The Check
 Check that the blue LED interior lights are illuminated when the vehicle Headlamps are on.	Interior lights should function with the Headlamps on.
 Check that the Foot Well Light illumination changes when using the vehicle Dimmer Switch.	Interior lights should become brighter and dimmer when operating the vehicle Dimmer Switch.
 Check the On / Off function of the Switch.	Interior Lights should turn on and off when switch is operated.
 Verify USB/AUX Port is functional by connecting a suitable media device to the USB port (Phone, MP3, Player, or USB device with music).	Music plays through stereo from USB/AUX Port and connector is installed correctly.
 Make sure the shift lever cannot be moved out of gear without the brake pedal depressed.	Shift lever and lock mechanism works normally.
 <b>Make sure to leave the interior lights ON after the Function Check is complete.</b>	<b>Interior lights are in the ON position after the Function Check is completed.</b>

## HYUNDAI Genuine Accessories Visual Check

Items To Be Checked	Results Of The Check
 Check that Blue LED Interior Lights are illuminated in both Driver and Passenger side Foot Well areas.	Blue LED Interior Lights are illuminated.

## HYUNDAI Genuine Accessories Troubleshooting

Issue / Concern	Item To Be Checked
 Blue LED interior lights not illuminated.	Check: - switch is in ON position, pushed in. - fuse is properly installed and intact. - that T-Taps are installed on the correct wires. - spade terminals are installed correctly to the T-Tap.
 Blue LED interior lights do not operate with the vehicle illumination circuit.	Check: - switch is in ON position, pushed in. - fuse is properly installed and intact. - that T-Taps are installed on the correct wires. - spade terminals are installed correctly to the T-Tap.
 Blue LED interior lights do not dim with vehicle illumination circuit.	Check: - switch is in ON position, pushed in. - fuse is properly installed and intact. - that T-Taps are installed on the correct wires. - spade terminals are installed correctly to the T-Tap.

# HYUNDAI Genuine Accessories Electrical Schematic

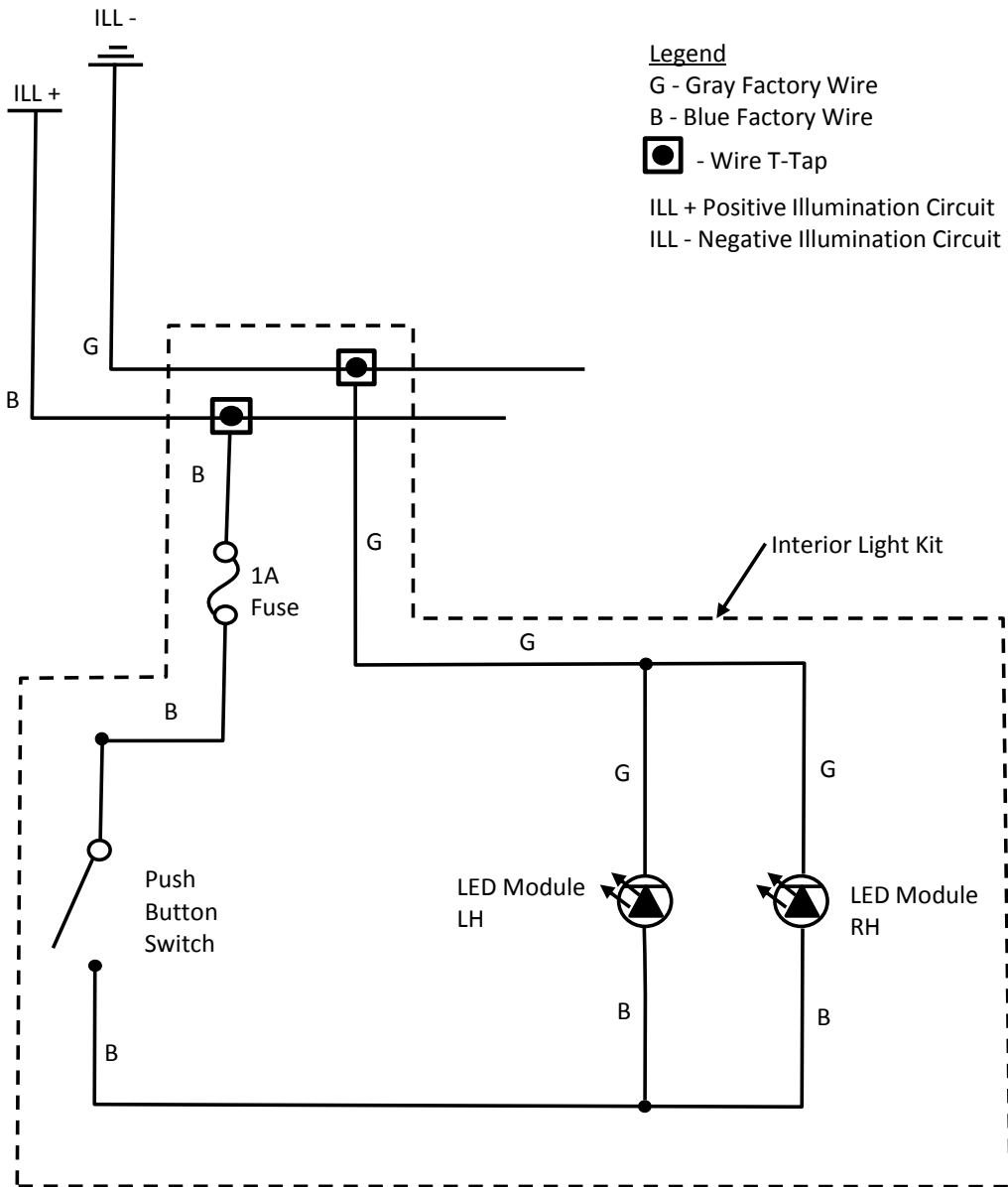

HYUNDAI Genuine Accessories  
Template - LED Module Passenger Side

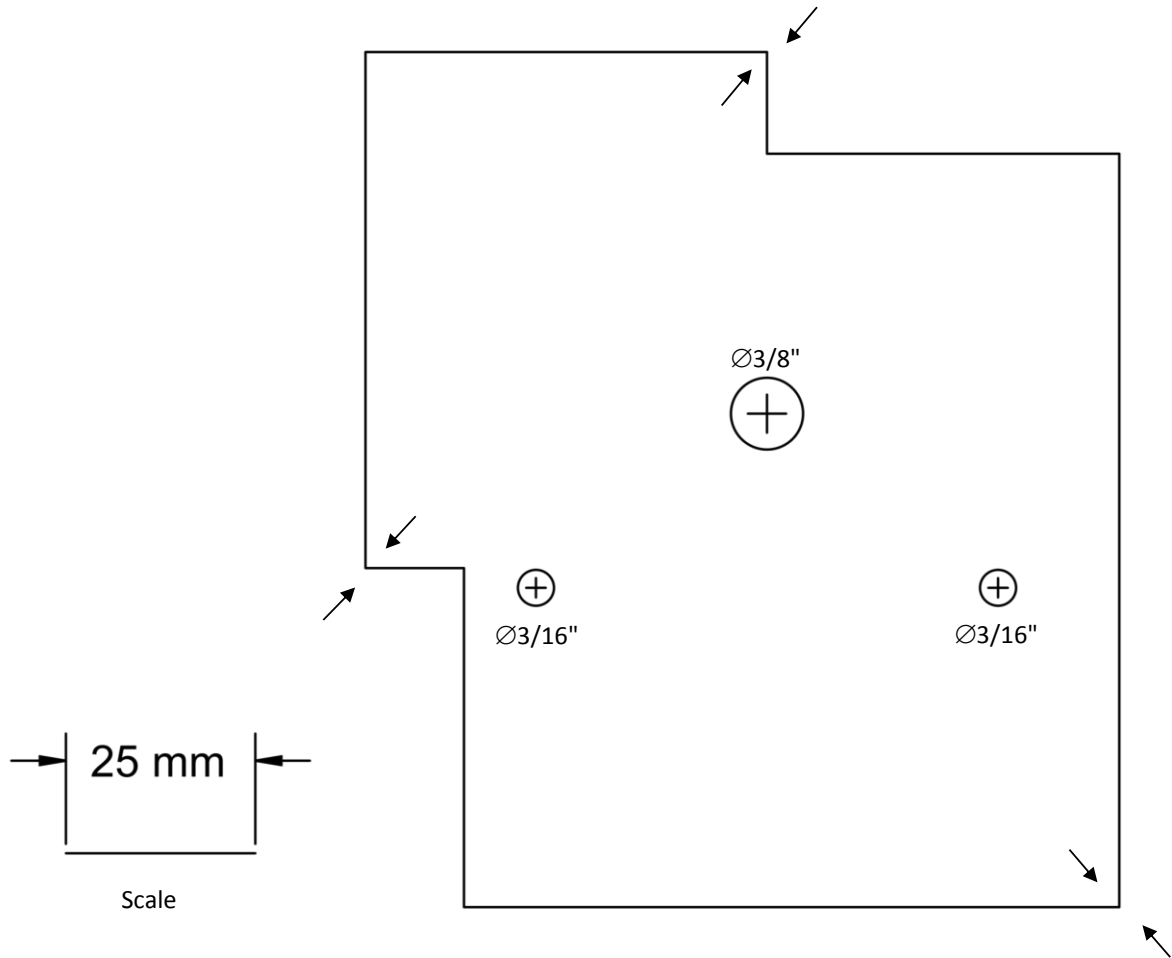

**Printing Instructions**

1. Select No Scale when printing.
2. Measure the Scale above to verify printer settings are correct.

**HYUNDAI Genuine Accessories**

**This page intentionally left blank**



**HYUNDAI Genuine Accessories  
Template - Switch Location**

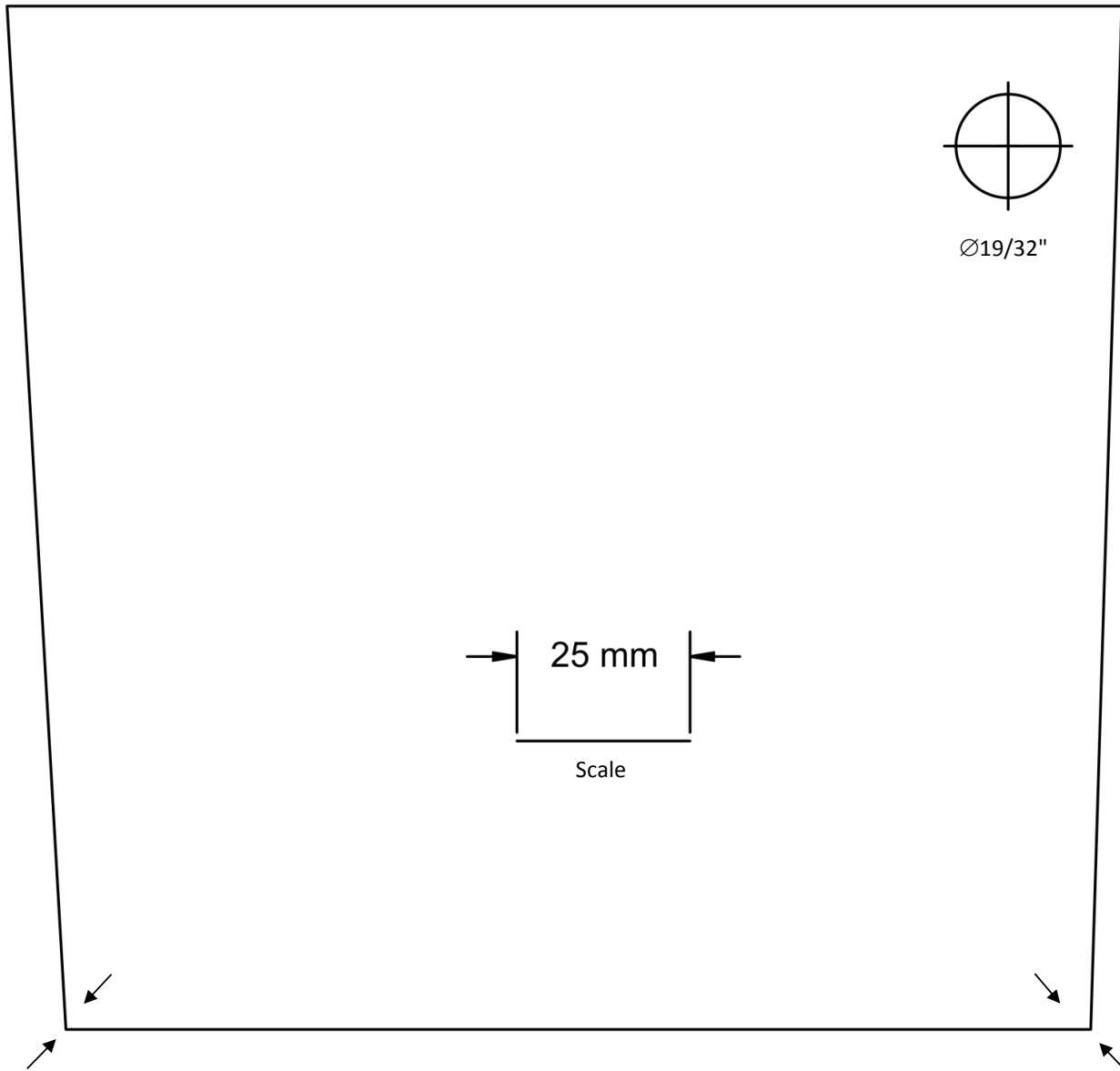

**Printing Instructions**

1. Select No Scale when printing.
2. Measure the Scale above to verify printer settings are correct.