



# HYUNDAI Genuine Accessories

Vehicle Model	Tucson	Accessory	Cargo Net
Model Year	2016 ~	Difficulty	( A )
Part No.	D3017 ADU00 D3017 ADUP0		

- Accessory Installation

**Note:** Difficulty stated above reflects the minimum level of expertise required to install the accessory.

( A ) Customer ( B ) Dealer Technician ( C ) Master Technician

## Instructional Symbols / Definitions

	Denotes warnings that may lead to serious physical injury or vehicle damage.		Denotes quality processes to be checked prior to moving to the next step.	Denotes safety equipment required to be used such as a mask, safety glasses, gloves, and hearing protection.	
	Denotes cautions to be taken to avoid physical injury or electronic component damage.		Denotes specific tools that are necessary to complete the step.		
	Denotes cautions to be taken to avoid vehicle and component damage.		Denotes instructional steps necessary to complete the process.		

## Basic Required Hand Tools

None

**FMVSS 110 Compliance Information**

**Part Number:**  
D3017 ADU00  
D3017 ADUP0

**0.43 lbs**  
**0.195 kg**  
**(Gross Weight)**

All dealers must determine if the weight they have added in the form of all options or accessories, when added to the weight of all Port/Dealer installed options or accessories, exceeds the lesser of 1.5% of GVWR or 100 lbs. If the additional weight does exceed the lesser of the indicated thresholds, a "Load Carrying Capacity Reduced" label must be installed. A black, fine-point, indelible marker must be used to write by hand onto the label, the reduced carrying capacity in kilograms or pounds, which is the total weight of all added options and accessories.  
Load Label Part Number: NP070 - 09003

### Notes to the Installer:

- 1) Read the entire installation instructions prior to beginning the installation of this accessory.
- 2) Make sure the vehicle is completely clean before the accessory is installed.
- 3) Ensure the vehicle is properly protected in the area(s) that the accessory is to be installed.
- 4) To prevent vehicle damage, never place tools on top of painted surfaces, seats, dash pad, console or floor carpet/mats.
- 5) Always wear appropriate safety gear to include gloves and safety glasses when required.

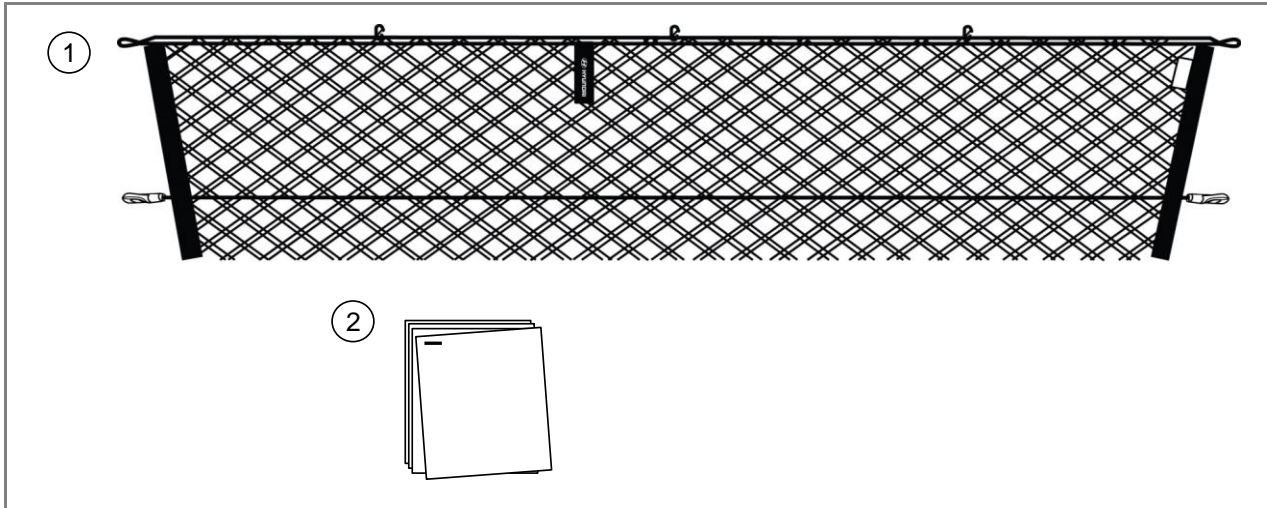

# HYUNDAI Genuine Accessories

## Kit Overview



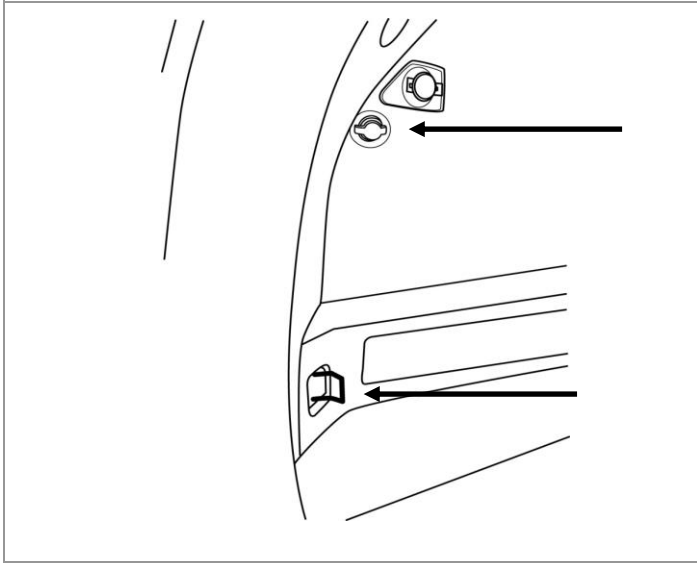

No.	Qty.	Description
1	1	Cargo Net
2	1	Installation Instructions



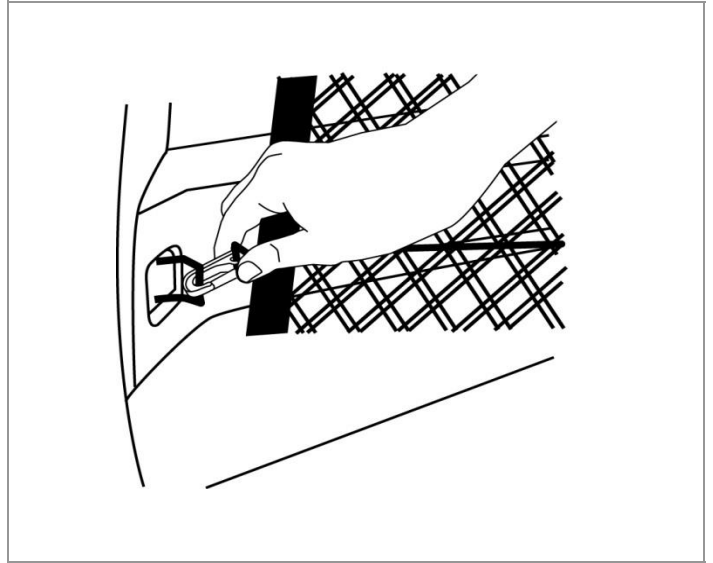

	1
NOTE	1. Open the rear cargo door and identify the driver side upper T-Anchor and lower D-Ring. 2. Orient the Cargo Net opening to the top position, and the Plastic Pull Handle is facing rearward.
	Ensure the Bungee Loop is securely fastened.

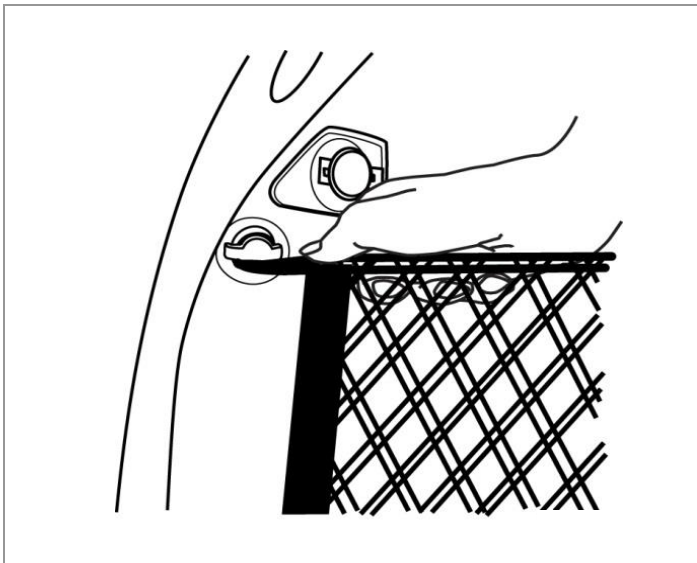

	2
NOTE	1. Attach the Hook at the bottom of the Cargo Net to the lower D-Ring as shown. 2. Repeat on opposite side.
	Ensure the Hook is securely fastened.



	3
NOTE	1. Attach the Cargo Net's upper Bungee Loop to the upper T-Anchor. 2. Repeat on opposite side.
	Ensure the Bungee Loop is securely fastened.

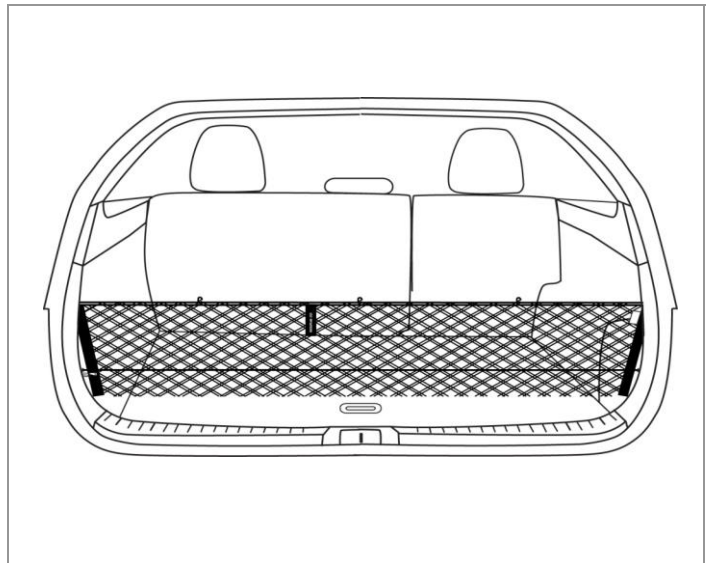

	4
NOTE	1. Correctly installed Cargo Net as shown.

## HYUNDAI Genuine Accessories

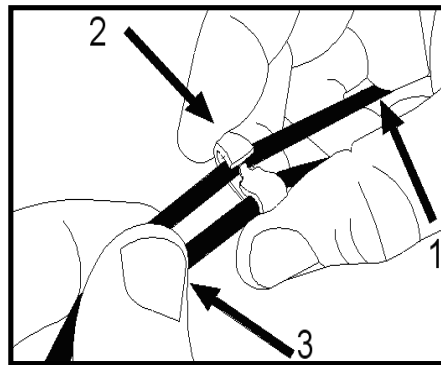
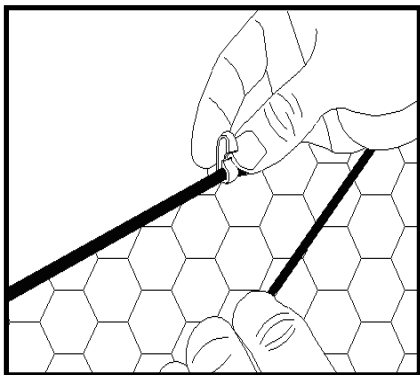

🔑		5
NOTE	1. Locate the three Hook Clips along the top of the Cargo Net.	

🔑		6
NOTE	1. Grasp the Bungee Cord you will be sliding into the Hook Clip and wrap two or three fingers around to hold securely. 2. With the same hand, use your index finger and thumb to hold the Hook Clip. 3. With the other hand, grasp the Bungee Cord and while pulling away from the Hook Clip, slide the Bungee Cord up into the Clip to fasten or pull out of the Clip to unfasten.	
✔	<b>Ensure the Bungee Cord is fully seated in the Hook Clips.</b>	

### Visual Check

	Items To Be Checked	Results Of The Check
✔	The position of the Cargo Net opening and Pull Tab.	The Cargo Net opening is at the top. Pull Tab is facing the rear of the vehicle.
✔	Ensure upper Bungee Loops are secure to the T-Anchors.	Bungee Loops secure to all T-Anchors.
✔	Ensure lower hooks are secured to the D-rings.	Hooks are secure to all D-rings.
✔	Confirm any customer belongings removed from the trunk are returned.	Customer belongings returned to the trunk.
✔	Ensure trunk is closed and latched.	Trunk is closed and latched.
✔	Installation Instructions placed inside the vehicle glove box.	Installation Instructions are inside the vehicle glove box.