

Genuine Accessories



Vehicle Model Elantra

Model Year 2017~
 Part No. F3045 ADU01
 Language English
 Rev. Date 3/28/2017

Accessory: Illuminated Door Scuff Plates

Difficulty: B

Note: Difficulty stated above reflects the minimum level of expertise required to install the accessory:
 (A) Customer
 (B) Dealer Technician
 (C) Master Technician or Specialist

Instructional Symbols / Definitions

	Denotes warnings that may lead to serious physical injury or vehicle damage		Denotes quality processes to be checked prior to moving to the next step	Denotes personal protective equipment (PPEs) that may be required for a step. Examples of safety equipment icons noted below:	
	Denotes cautions to be taken to avoid physical injury or electronic component damage		Denotes specific tools that are necessary to complete a step		
	Denotes cautions to be taken to avoid vehicle and component damage	N O T E	Denotes important information to be reviewed during the step		
				Glasses	Gloves
				Mask	Hearing Protection

Basic Required Tools

Plastic Trim Removal Tool	Clean Cloth	Masking Tape	50/50 Isopropyl Alcohol (70%) and Water

Part Weight (Gross)

1.00	lbs
0.44	kg

FMVSS 110 Compliance Information

All dealers must determine if the weight they have added in the form of all options or accessories, when added to the weight of all Port/Dealer Installed options or accessories, exceeds the lesser of 1.5% of GVWR or 100 lbs. If the additional weight does exceed the lesser of the indicated thresholds, a "Load Carrying Capacity Reduced" label must be installed. A black, fine-point, indelible marker must be used to write by hand onto the label, the reduced carrying capacity in kilograms or pounds, which is the total weight of all added options and accessories.
Load Label Part Number: NP070 - 09003

Notes to the installer:

- 1 Read the entire Installation Instructions prior to beginning the installation of the part.
- 2 Make sure the vehicle is completely clean and dry in the area(s) the part is to be installed.
- 3 Ensure the vehicle is properly protected in the area(s) that the accessory is to be installed.
- 4 NEVER place tools on painted surfaces, seating surfaces, dash pad, console or floor carpet/mats.
- 5 Always wear appropriate personal protective equipment, including gloves, safety glasses, etc., when required.

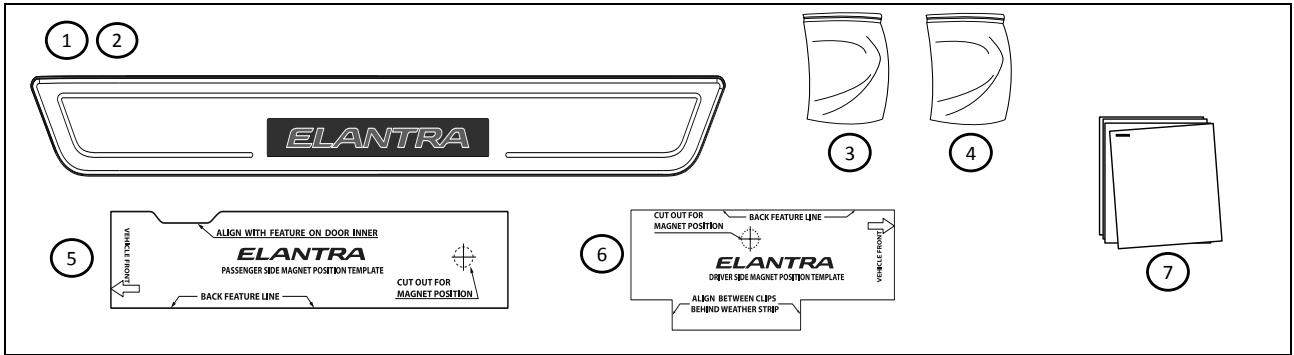

Genuine Accessories

Kit Overview



No.	Qty	Description
1	1	Scuff Plate R, Illuminated
2	1	Scuff Plate L, Illuminated
3	1	Hardware Bag, Battery
4	1	Hardware Bag, Magnets
5	1	Magnet Position Template, Passenger Side
6	1	Magnet Position Template, Driver Side
7	1	Installation Instructions



Hardware Kit Contents

A		B		C	
2	Magnet	2	Magnet Holder	4	Battery

Hardware Total
8

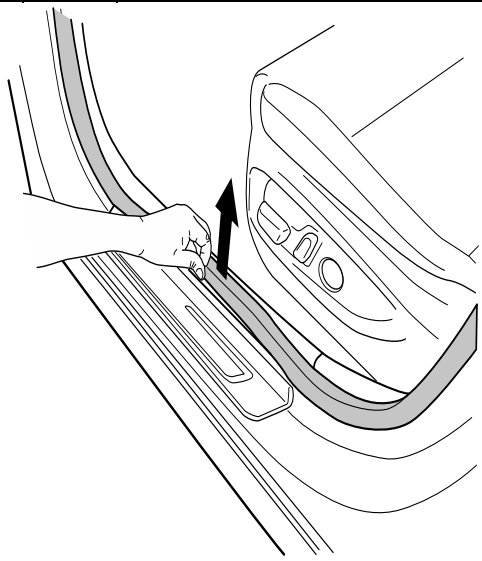
Genuine Accessories

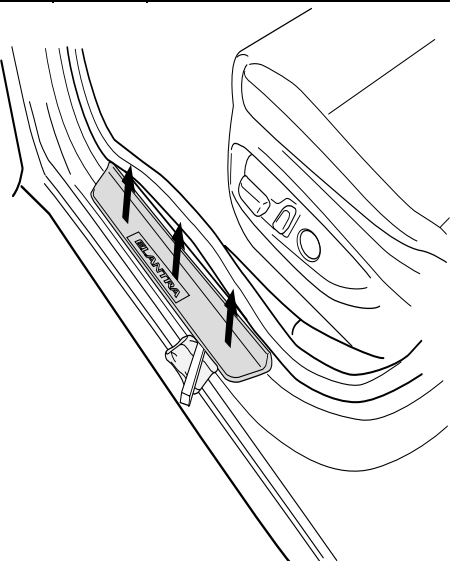
1		
		
N O T E	<ol style="list-style-type: none"> 1. Starting on the driver's side, open the driver door. 2. Dislodge the weatherstrip near the factory Door Scuff Plate. 	

2		Plastic Trim Removal Tool and Clean Cloth
		
N O T E	<ol style="list-style-type: none"> 1. Remove the driver factory Door Scuff Plate. Use a clean cloth under the plastic trim removal tool when removing the factory Door Scuff Plate. 2. Discard the removed part. 	
		<p>CAUTION! Do not damage the vehicle paint when removing the factory Door Scuff Plate.</p>

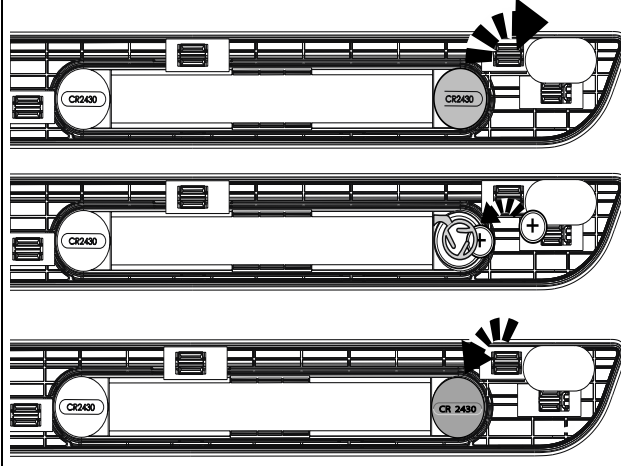
3		
		
N O T E	<ol style="list-style-type: none"> 1. Remove battery covers. 2. Install batteries from hardware kit as shown. Make sure the battery is installed with the positive side placed up and within the retainer clips as shown. 3. Replace the battery covers. 	

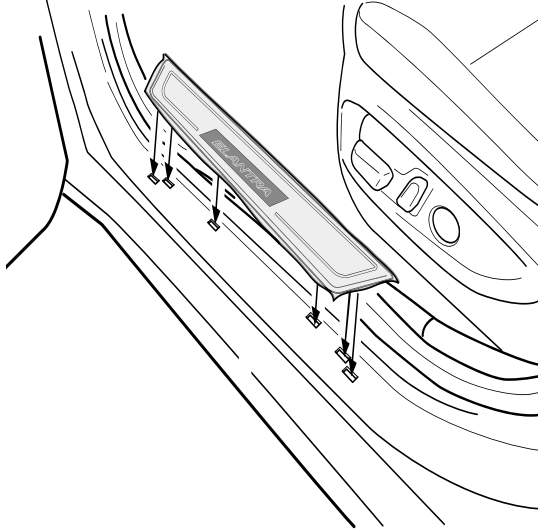
4		
		
N O T E	<ol style="list-style-type: none"> 1. Install the driver's (L) Illuminated Door Scuff Plate by aligning the six (6) plastic tabs with the vehicle holes, as shown. 	

5	🔑	
N O T E	<ol style="list-style-type: none"> 1. Press down firmly on the scuff plate to fully engage the clips. -An audible "click" will be heard when each plastic tab is fully engaged. 2. Reinstall the weatherstrip dislodged in step 1. 	

6	🔑	50/50 Isopropyl Alcohol (70%) and Water and Clean Cloth
N O T E	<ol style="list-style-type: none"> 1. Using a 50/50 Isopropyl Alcohol (70%) and Water solution, clean the underside of the driver's door, as shown. 	

7	🔑	
N O T E	<ol style="list-style-type: none"> 1. Locate the Driver Side Magnet Position Template included in the kit. 	

8	🔑	Masking Tape
N O T E	<ol style="list-style-type: none"> 1. Locate the four (4) retaining clips holding the weatherstrip to the door as shown. 2. Position the Driver Side Magnet Position Template between clips 1 & 2, closest to the rear, as shown. 3. Attach the driver's side magnet position template to the underside of the driver's door using masking tape, as shown. 	

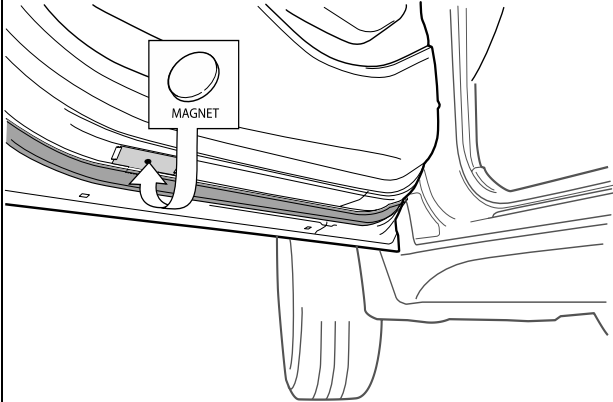

Genuine Accessories

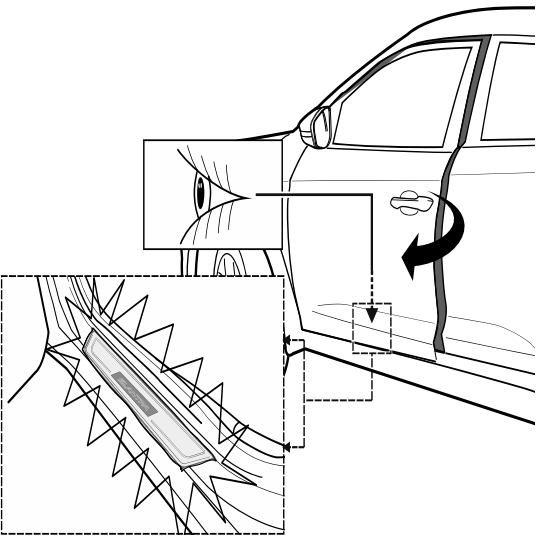
9		
		
N O T E	<ol style="list-style-type: none"> Place one (1) provided magnet into the hole marked "Cut Out For Magnet Position" indicated in the template. 	

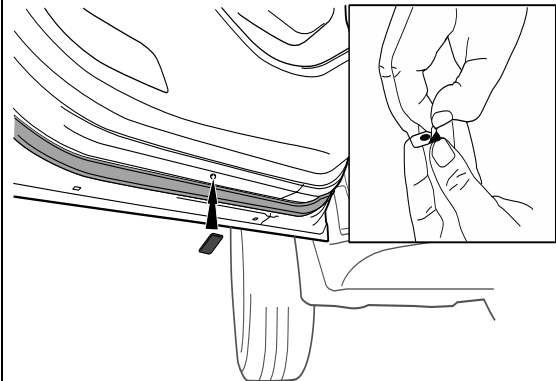
10		
		
N O T E	<ol style="list-style-type: none"> Open the driver's door, and confirm the scuff plate illuminates, as shown. <ul style="list-style-type: none"> -If the scuff plate does not illuminate or the light is blinking, the magnet may be in the wrong position. Recheck the position by going back to Steps 8-9. 	

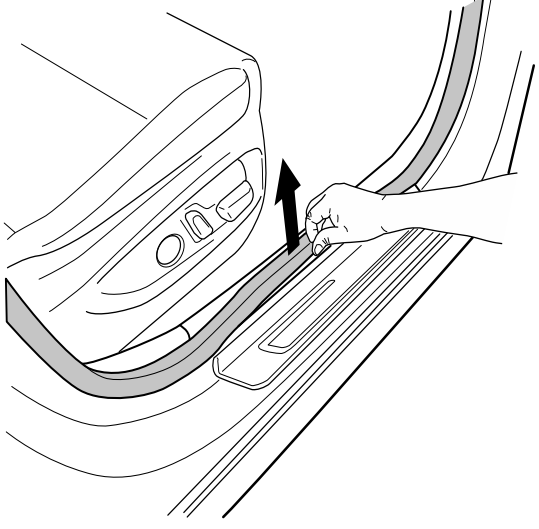
11		
		
N O T E	<ol style="list-style-type: none"> Remove the template and tape. Remove the adhesive liner from one (1) Magnet Holder. Position the Magnet Holder over the magnet. Press the Magnet Holder firmly to ensure proper adhesion to the vehicle door frame. Close the driver's door. 	

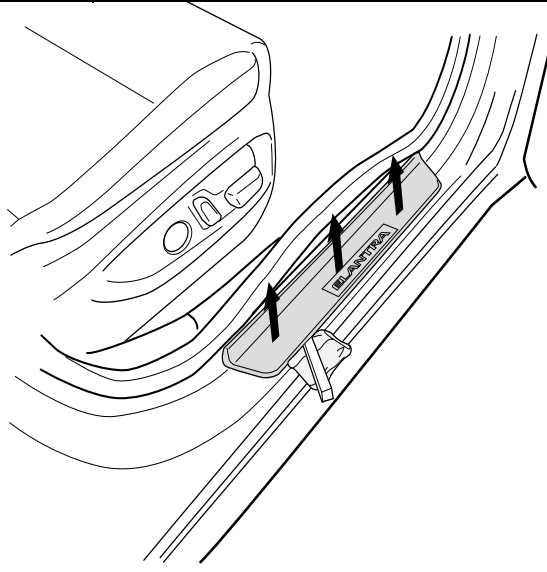
12		
		
N O T E	<ol style="list-style-type: none"> Open the passenger door. Dislodge the weatherstrip near the factory Door Scuff Plate. 	

13		Plastic Trim Removal Tool and Clean Cloth
		
N O T E	<ol style="list-style-type: none"> 1. Remove the passenger factory Door Scuff Plate. Use a clean cloth under the plastic trim removal tool when removing the factory Door Scuff Plate. 2. Discard the removed part. 	
 CAUTION! Do not damage the vehicle paint when removing the factory Door Scuff Plate.		

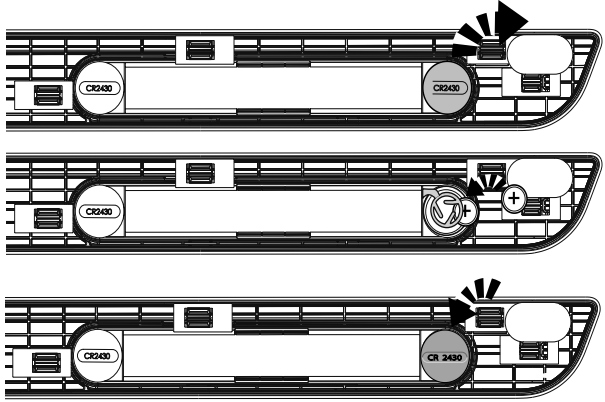
14		
		
N O T E	<ol style="list-style-type: none"> 1. Remove battery covers. 2. Install batteries from hardware kit as shown. Make sure the battery is installed with the positive side placed up and within the retainer clips as shown. 3. Replace battery covers. 	

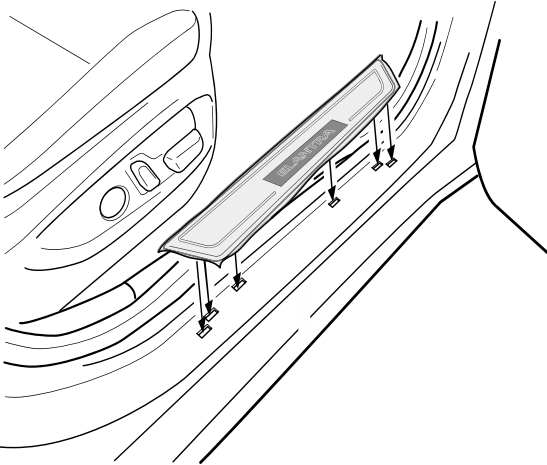
15		
		
N O T E	<ol style="list-style-type: none"> 1. Install the passenger's (R) illuminated door scuff plate by aligning the six (6) plastic tabs, as shown. 	

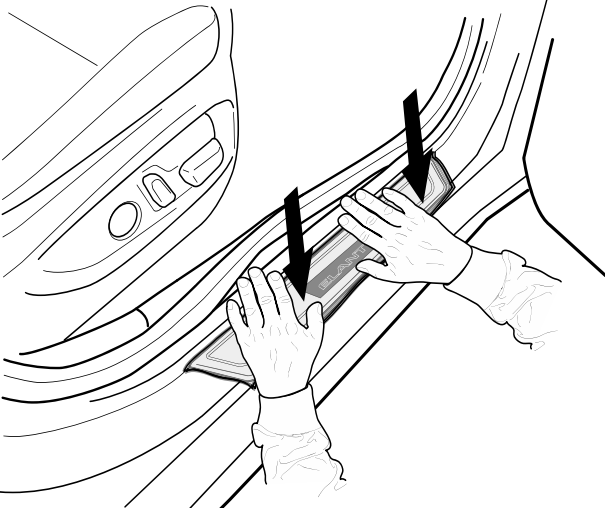
16		
		
N O T E	<ol style="list-style-type: none"> 1. Press down firmly on the scuff plate to fully engage the clips. -An audible "click" will be heard when each plastic tab is fully engaged. 2. Reinstall the weatherstrip dislodged in step 12. 	

Genuine Accessories

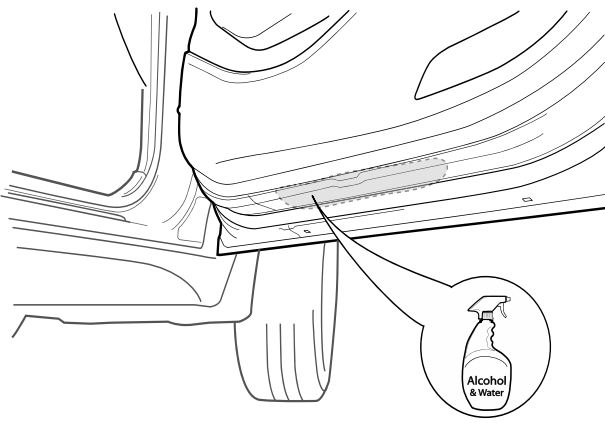
17		50/50 Isopropyl Alcohol (70%) and Water and Clean Cloth
		
N O T E	<p>1. Using a 50/50 Isopropyl Alcohol (70%) and Water solution, clean the underside of the passenger's door, as shown.</p>	

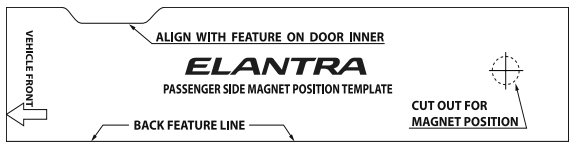
18		
		
N O T E	<p>1. Locate the Passenger Side Magnet Position Template included in the kit.</p>	

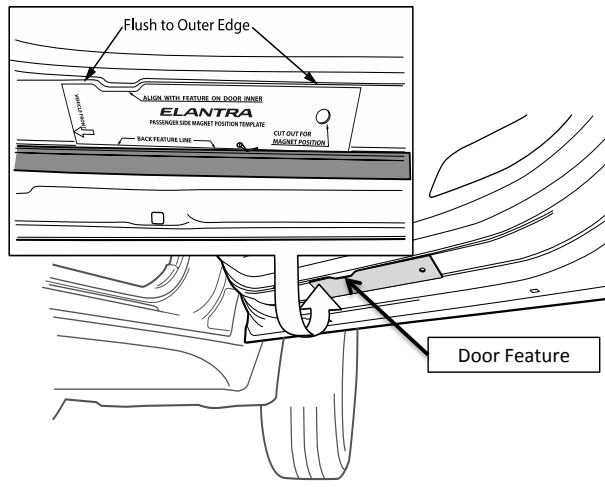
19		Masking Tape
		
N O T E	<p>1. Attach the passenger's side magnet position template to the underside of the passenger's door using masking tape, as shown. Be sure to align the template to the door feature and flush to the outer door edge.</p>	

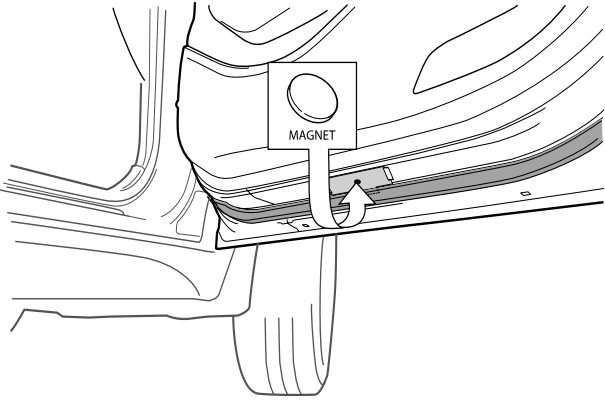
20		
		
N O T E	<p>1. Place one (1) provided magnet into the hole marked "Cut Out For Magnet Position" indicated in the template.</p>	

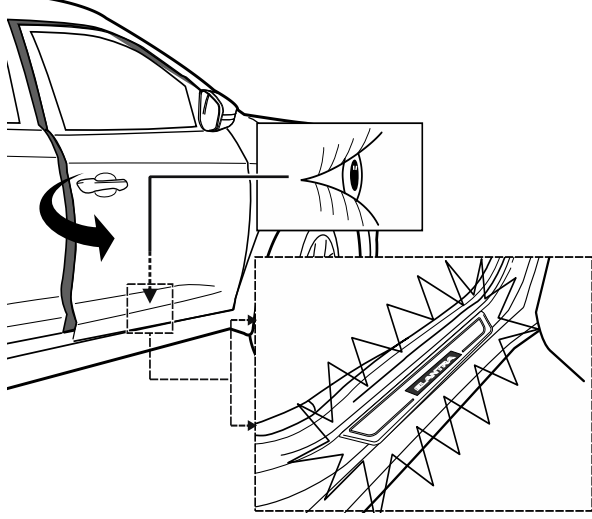

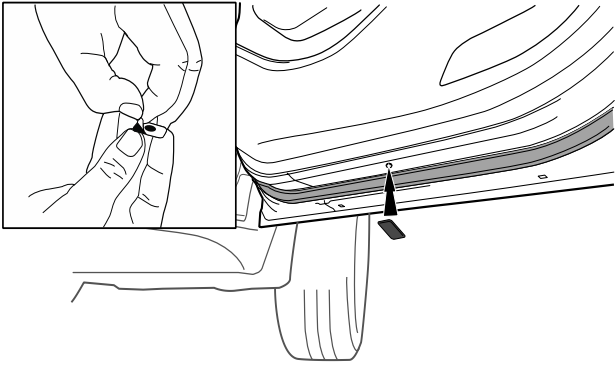
21		
		
N O T E	<ol style="list-style-type: none"> 1. Open the passenger's door, and confirm the scuff plate illuminates, as shown. -If the scuff plate does not illuminate or the light is blinking, the magnet may be in the wrong position. Recheck the position by going back to Steps 19-20. 	

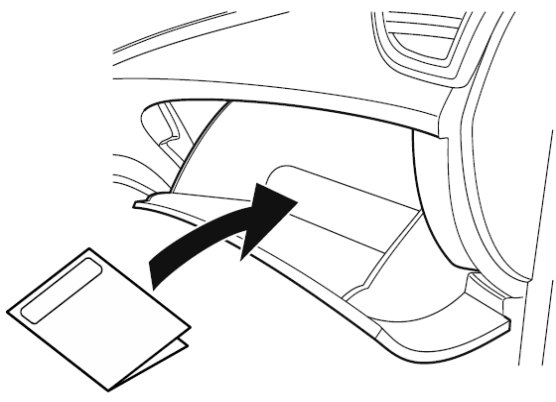
22		
		
N O T E	<ol style="list-style-type: none"> 1. Remove the template and tape. 2. Remove the adhesive liner from one (1) Magnet Holder. 3. Position the Magnet Holder over the magnet. 4. Press the Magnet Holder firmly to ensure proper adhesion to the vehicle door frame. 5. Close the passenger's door. 	

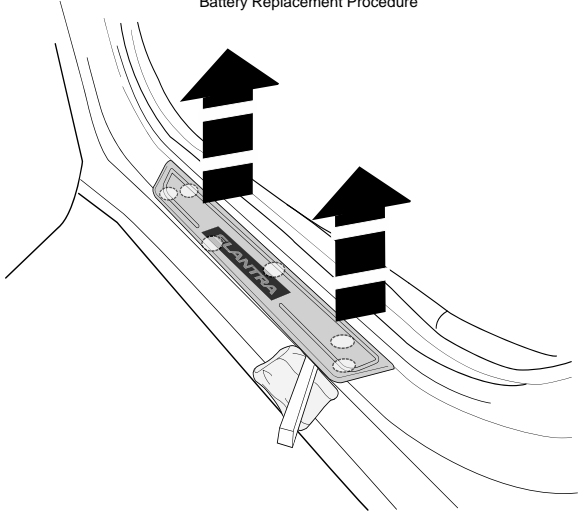
23		50/50 Isopropyl Alcohol (70%) and Water and Clean Cloth
		
N O T E	<ol style="list-style-type: none"> 1. Perform the Function Check and Visual Check at the end of the installation instructions for both Driver and Passenger Illuminated Scuff Plates. 2. Place the Installation Instructions, containing the Battery Replacement Procedure, in the glove box. 3. Remove and discard the protective film from each illuminated scuff plate. 4. Using a 50/50 Isopropyl Alcohol (70%) and Water solution, clean the Driver and Passenger Illuminated Scuff Plates to remove any dirt or tape residue. 	

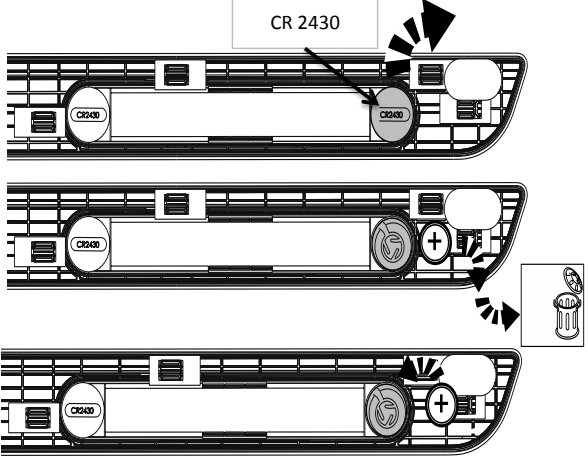
A		Plastic Trim Removal Tool and Clean Cloth
Battery Replacement Procedure		
		
N O T E	<p>If the scuff plate logo stops illuminating after the door is opened, it may be necessary to replace the batteries. To replace the batteries:</p> <ol style="list-style-type: none"> Carefully remove the scuff plate by prying upwards with a Plastic Trim Removal Tool. <ul style="list-style-type: none"> -Place a Clean Cloth under the tool to prevent damage to the vehicle's paint. -Pry upwards at the clip locations. 	

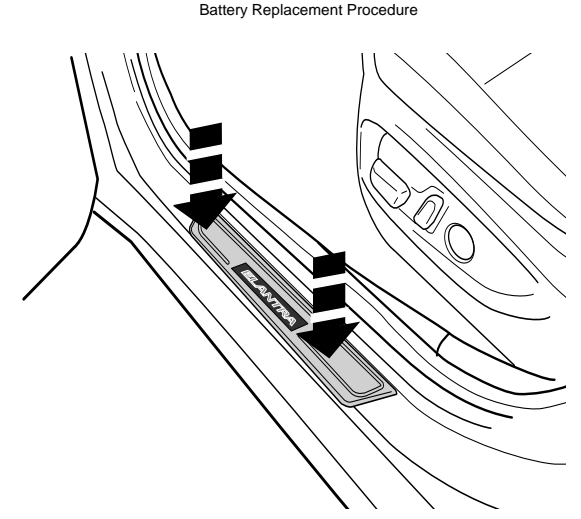
B		
Battery Replacement Procedure		
		
N O T E	<ol style="list-style-type: none"> Identify the two (2) battery covers located on the underside of the scuff plates. The battery cover is labeled CR 2430. Dislodge the battery covers to access each battery. Carefully slide each battery out of the retainer clips on the scuff plate. Discard according to local regulations. Insert two (2) new CR 2430 batteries into the retainer clips. Replace battery covers. 	

C		
Battery Replacement Procedure		
		
N O T E	<ol style="list-style-type: none"> Reinstall the scuff plate by aligning the six (6) plastic tabs, as shown. Press down firmly on the scuff plate. <ul style="list-style-type: none"> -An audible "click" will be heard when each plastic tab is fully engaged. Close the door. 	
	<p>CAUTION! To avoid damaging the Scuff Plate unnecessarily, remove only the scuff plate that requires new batteries, not both.</p>	

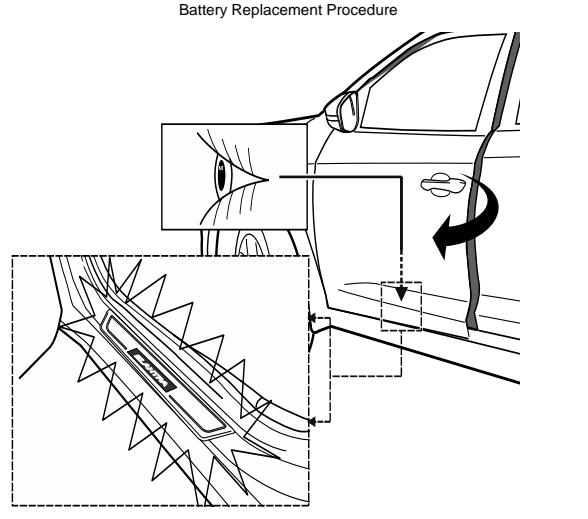
D		
Battery Replacement Procedure		
		
N O T E	<ol style="list-style-type: none"> Open the door and confirm the scuff plate logo illuminates properly. 	

Genuine Accessories

Visual Check

Item to be Checked	Result
<div style="display: flex; align-items: center;"> Ensure the scuff plates are fully secured to the vehicle. </div>	Scuff plates are not loose, or mis-set.
<div style="display: flex; align-items: center;"> Ensure the scuff plates are not damaged </div>	Scuff plates function properly, and have no cosmetic defects.

Function Check

Item to be Checked	Result
<div style="display: flex; align-items: center;"> Each scuff plate illuminates when the door is opened. </div>	The scuff plate illuminates properly when the door opens. The scuff plate light does not blink.

Troubleshooting

Issue / Concern	Items to be Checked
<div style="display: flex; align-items: center;"> The scuff plate does not illuminate properly. </div>	Check that the magnet is still properly adhered to the vehicle. Check that the magnet is properly aligned, by using a template. Check that the batteries are not fully discharged.