



Vehicle Model: **Elantra GT**

Model Year 2018-  
 Part No. G3F28 AU000 (DIO)  
G3F28 AU600 (PIO)  
 Language English  
 Rev. Date 12/7/2016

Accessory: **Applique, Rear Bumper**

Difficulty: (B)

**Note:** Difficulty stated above reflects the minimum level of expertise required to install the accessory:  
 (A) Customer  
 (B) Dealer Technician  
 (C) Master Technician or Specialist

Instructional Symbols / Definitions

	Denotes warnings that may lead to serious physical injury or vehicle damage		Denotes quality processes to be checked prior to moving to the next step	Denotes personal protective equipment (PPEs) that may be required for a step. Examples of safety equipment icons noted below:	
	Denotes cautions to be taken to avoid physical injury or electronic component damage		Denotes specific tools that are necessary to complete a step		
	Denotes cautions to be taken to avoid vehicle and component damage	<b>N O T E</b>	Denotes important information to be reviewed during the step		
				Glasses	Gloves
				Mask	Hearing Protection

Basic Required Tools

50/50 Isopropyl Alcohol (70%) & Water	Alcohol, Soap & Water (SLIP Mixture)	Microfiber Cloth

Part Weight (Gross)	
<b>31.6</b>	g
<b>1.11</b>	oz.

**FMVSS 110 Compliance Information**  
 All dealers must determine if the weight they have added in the form of all options or accessories, when added to the weight of all Port/Dealer Installed options or accessories, exceeds the lesser of 1.5% of GVWR or 100 lbs. If the additional weight does exceed the lesser of the indicated thresholds, a "Load Carrying Capacity Reduced" label must be installed. A black, fine-point, indelible marker must be used to write by hand onto the label, the reduced carrying capacity in kilograms or pounds, which is the total weight of all added options and accessories.  
**Load Label Part Number: NP070 - 09003**

Notes to the installer:



- 1) Read the entire installation instructions prior to beginning the installation of this accessory.
- 2) Make sure the vehicle is completely clean before the accessory is installed.
- 3) Ensure the vehicle is properly protected in the area(s) that the accessory is to be installed.
- 4) To prevent vehicle damage, never place tools on top of painted surfaces, seats, dash pad, console or floor carpet/mats.
- 5) Always wear appropriate safety gear to include gloves and safety glasses when required.
- 6) Alcohol, Soap & Water Mixture: Mix 8 oz. of water, 8 oz. alcohol (70% isopropyl) & 1 ml of baby shampoo in a trigger type spray bottle marked "SLIP". **Note:** The above listed solution has been formulated for use where ambient & vehicle surface temperatures are within a range of 65°F to 90°F. If temperatures exceed this range, add additional shampoo in increments of 1 ml to aid in alignment.
- 7) Install this product while observing all warnings and precautions stated in these installation instructions.
- 8) **VERY IMPORTANT:** Thoroughly clean rear bumper area with soap and water. If contaminants are found, clean with an automotive grade clay bar (follow instructions provided with clay bar).
- 9) **VERY IMPORTANT:** Ambient temperature of the rear bumper area and vehicle must be 65°F to 90°F at the time of installation and for two hours after.
- 10) Parts storage should be at room temperature and in a clean dry place. Care should be taken to avoid a dusty environment.
- 11) Place a large towel or pad on the ground to catch wetting mixture and avoid slippery floor.

# Genuine Accessories

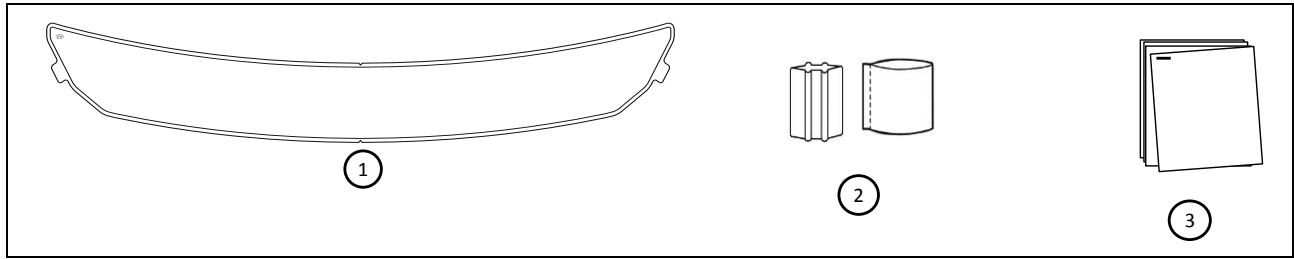

## Kit Overview

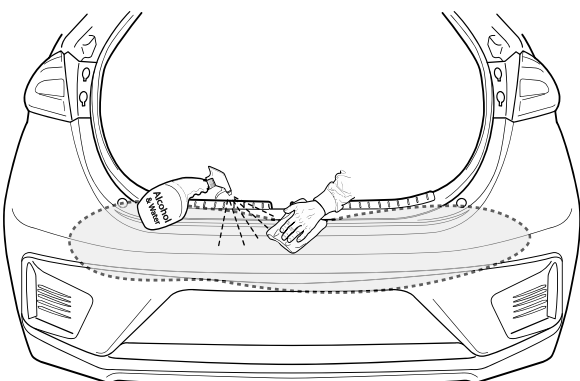



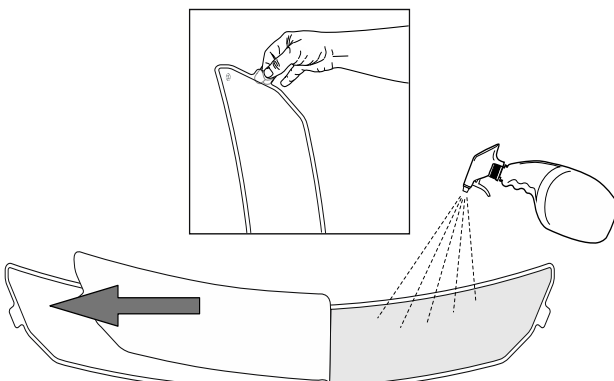

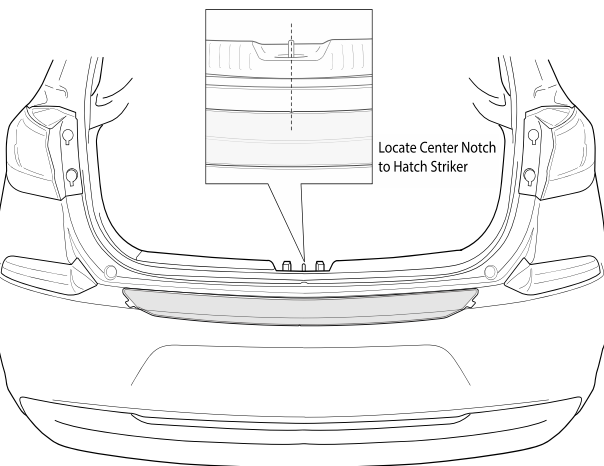
No.	Qty	Description
1	1	Rear Bumper Applique
2	1	Squeegee with Sleeve
3	1	Installation Instructions

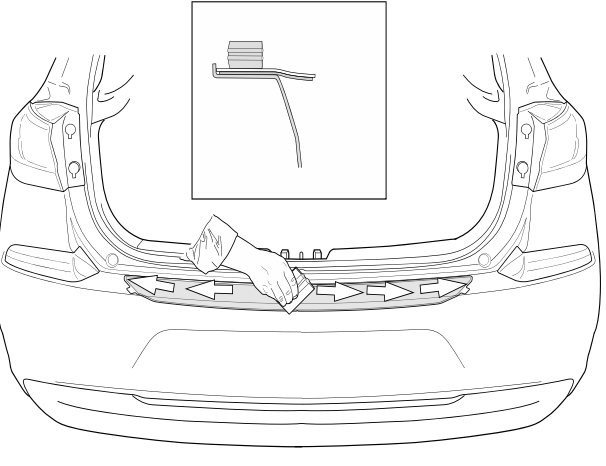

1		50/50 Isopropyl Alcohol (70%) & Water and a Microfiber Cloth
		
		
N O T E	<p>1. Thoroughly clean the bumper area using the 50/50 Isopropyl Alcohol (70%) &amp; Water and Microfiber Cloth.</p>	
	<p>Make sure the bumper area is completely clean and dried.</p>	

2		Alcohol, Soap & Water (SLIP Mixture)
		
N O T E	<p>1. Prior to installation, wet your hands with the SLIP mixture and ensure your hands stay wet during the installation. 2. Remove the liner from the Rear Bumper Applique, then spray the Rear Bumper Applique with SLIP mixture.</p>	

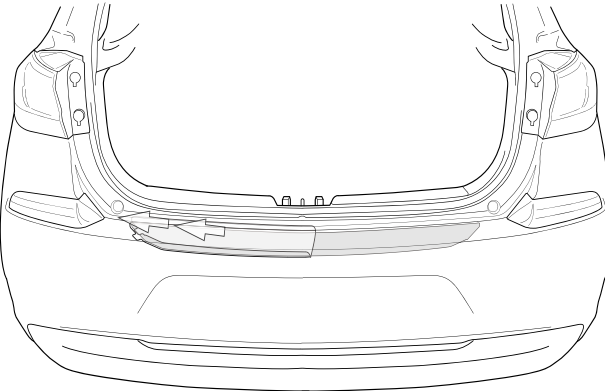
3		Alcohol, Soap & Water (SLIP Mixture)
		
N O T E	<p>1. Wet the vehicle with the SLIP mixture, position the Rear Bumper Applique onto the bumper by visually aligning the center notch in pre-mask to the hatch striker, as shown. 2. If necessary, spray additional SLIP mixture to aid in installation.</p>	
	<p>Bumper must be wet to aid in installation.</p>	



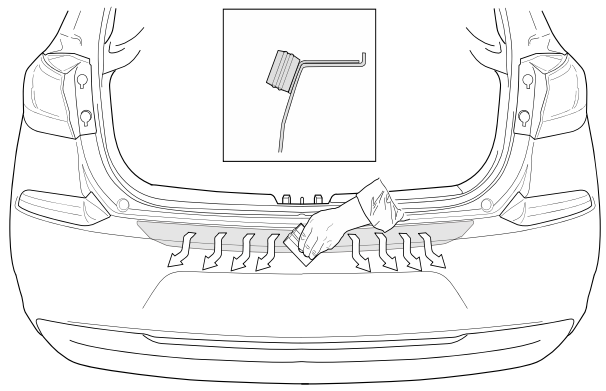

4		Alcohol, Soap & Water (SLIP Mixture) and Squeegee with Sleeve
		
N O T E	<p>1. Wet pre-mask on top of Rear Bumper Applique with the SLIP mixture. 2. Starting in the center, squeegee the Rear Bumper Applique firmly onto the top surface of the bumper using overlapping strokes in a side to side motion.</p>	
	<p>Make sure Sleeve is installed on Squeegee. Bumper must be wet to aid in installation.</p>	

5		
		
N O T E	<p>1. Remove pre-mask by pulling back at 180° against itself.</p>	
	<p><b>Do not pull straight up on pre-mask during removal. Peel pre-mask at a constant 180° to ensure the placement of the Rear Bumper Applique does not move. Inspect for bubbles and correct following the procedure on page 5.</b></p>	

6		Alcohol, Soap & Water (SLIP Mixture) and Squeegee with Sleeve
		
N O T E	<p>1. Re-wet the Bumper Applique with the SLIP mixture and re-squeegee the leading edge of the bumper fascia as shown above. 2. Dry installation area and check for proper fit. Remove and replace Bumper Applique if it is not properly installed.</p>	
	<p><b>Make sure Sleeve is installed on Squeegee. Bumper must be wet to aid in installation. Inspect for bubbles and correct following the procedure on page 5.</b></p>	

## Genuine Accessories

### Visual Check

Item to be Checked		Result
	Use only the handling tabs on the Rear Bumper Applique. Pay special attention to not get any fingerprints or dirt on the Rear Bumper Applique.	No dirt or fingerprints on Rear Bumper Applique.
	Make sure Rear Bumper Applique is fully adhered.	Rear Bumper Applique is not lifting and is fully adhered. Take special care to make sure all edges are fully adhered.
	Make sure no air bubbles are trapped under Rear Bumper Applique.	No adhesive remaining on Rear Bumper Applique.
	Make sure Rear Bumper Applique is free of any remaining adhesive after installation. Clean the Rear Bumper Applique with soap and water if necessary.	Rear Bumper Applique is installed correctly.
	If an installation error occurs, i.e., scratched / marred Rear Bumper Applique, dirt / debris under Rear Bumper Applique, crooked installation, etc., installer should remove, discard and replace the Rear Bumper Applique.	Rear Bumper Applique is installed correctly.