

Genuine Accessories



Vehicle Model: **Palisade**

Model Year 2020-

Part No. S8H15 AK000 NNB

Language English

Rev. Date 3/4/2019

Accessory: **Cargo Screen**

Difficulty: (A)

Note: Difficulty stated above reflects the minimum level of expertise required to install the accessory:

- (A) Customer
- (B) Dealer Technician
- (C) Master Technician or Specialist









Electronic Installation Instructions



If this is a printed copy of the installation instructions, ensure you have the latest revision by scanning the QR code or by entering the website address listed below before beginning installation. Use the latest revision date as noted by "Rev. Date" above.

www.hyundaiaccessories.com/admin_media_uploads/installationSheets/s8h15_ak000.pdf

Instructional Symbols / Definitions

 Denotes warnings that may lead to serious physical injury or vehicle damage	 Denotes quality processes to be checked prior to moving to the next step	Denotes personal protective equipment (PPEs) that may be required for a step. Examples of safety equipment icons noted below:
 Denotes cautions to be taken to avoid physical injury or electronic component damage	 Denotes specific tools that are necessary to complete a step	 Glasses
 Denotes cautions to be taken to avoid vehicle and component damage	<p style="text-align: center;">N O T E</p> Denotes important information to be reviewed during the step	 Gloves
		 Mask
		 Hearing Protection

Basic Required Tools

None

Part Weight (Gross)

6.35	lbs
2.88	kg

FMVSS 110 Compliance Information

All dealers must determine if the Net weight they have added in the form of all options or accessories, when added to the weight of all Port/Dealer Installed options or accessories, exceeds the lesser of 1.5% of GVWR or 100 lbs. If the additional weight does exceed the lesser of the indicated thresholds, a "Load Carrying Capacity Reduced" label must be installed. A black, fine-point, indelible marker must be used to write by hand onto the label, the reduced carrying capacity in kilograms or pounds, which is the total weight of all added options and accessories.

Load Label Part Number: NP070 - 09003

Notes to the installer:



- 1) Read the entire Installation Instructions prior to beginning the installation of this accessory.
- 2) Make sure the vehicle is completely clean and dry in the area(s) the part is to be installed.
- 3) Ensure the vehicle is properly protected in the area(s) that the accessory is to be installed.
- 4) NEVER place tools on painted surfaces, seating surfaces, dash pad, console or floor carpet/mats.
- 5) Always wear appropriate personal protective equipment, including gloves, safety glasses, etc., when required.

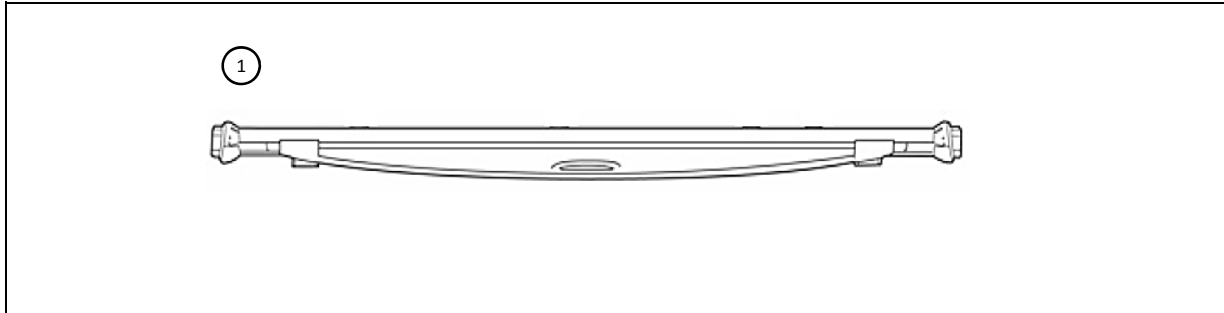

Kit Overview



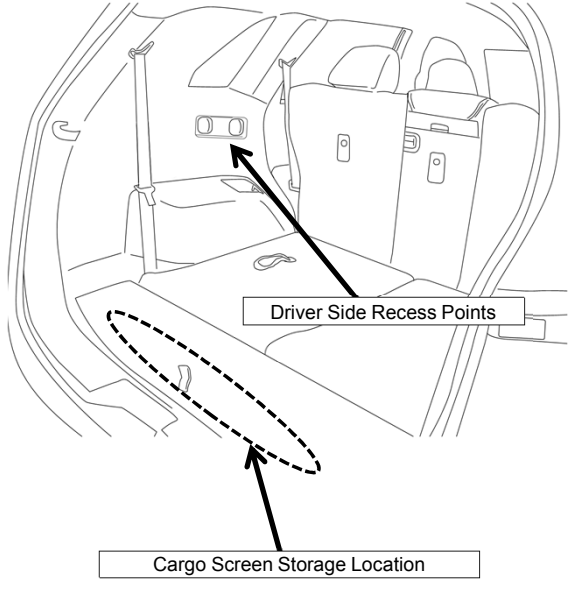

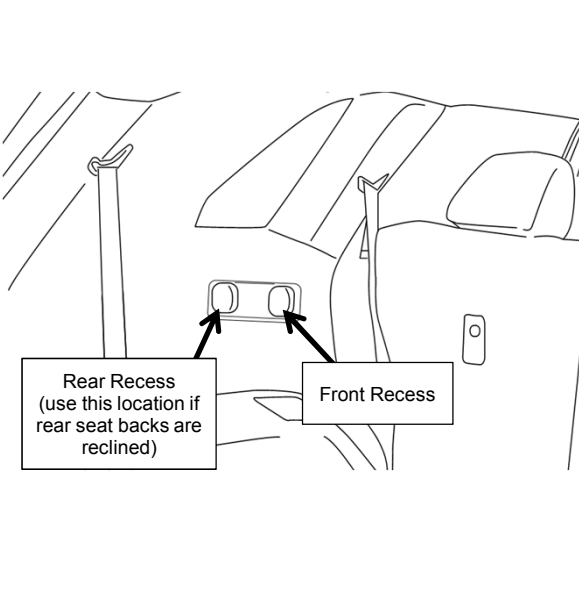

No.	Qty	Description
1	1	Cargo Screen

Genuine Accessories

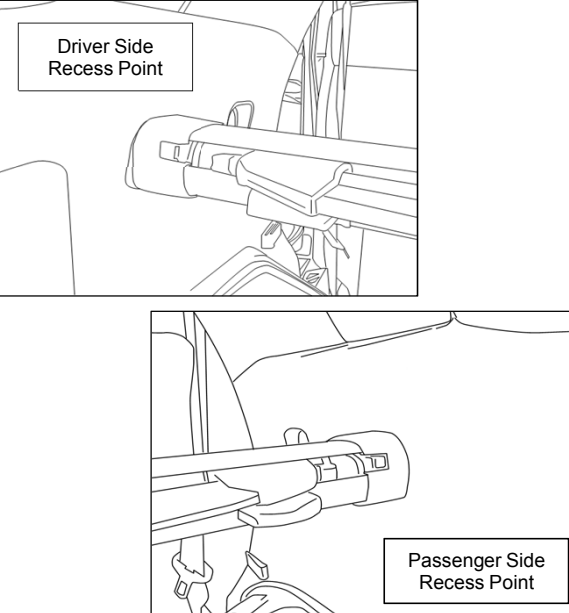
1	
 <p style="text-align: center;">Driver Side Recess Points</p> <p style="text-align: center;">Cargo Screen Storage Location</p>	
N O T E	<p>A. Locate the two (2) mounting recesses on both the left and right sides of the rear cargo area as shown.</p>
	<p>The Cargo Screen can be secured in the storage area under the cargo floor when not in use.</p>

2	
 <p style="text-align: center;">Rear Recess (use this location if rear seat backs are reclined)</p> <p style="text-align: center;">Front Recess</p>	
N O T E	<p>A. Select the desired front or rear position for the Cargo Screen. B. Position the Cargo Screen with the pull handle facing rearward. C. Insert the Cargo Screen into the selected Driver Side Recess.</p>
	<p>Do not damage the Trim Panels during installation.</p>

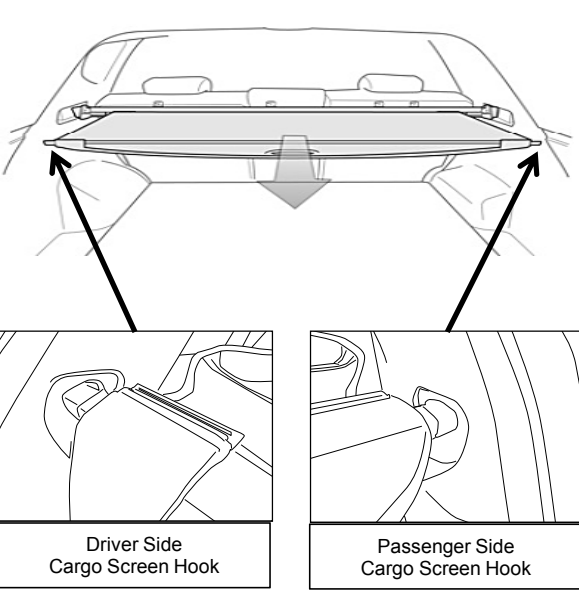
3	
 <p style="text-align: center;">Driver Side Recess Point</p> <p style="text-align: center;">Passenger Side Recess Point</p>	
N O T E	<p>A. While compressing the Cargo Screen into the left side recess, install the right end of the Cargo Screen into the right side recess.</p>

4	
 <p style="text-align: center;">Driver Side Cargo Screen Hook</p> <p style="text-align: center;">Passenger Side Cargo Screen Hook</p>	
N O T E	<p>A. Pull the screen out from the housing using the handle located at the middle of the Cargo Screen. B. Insert the left and right hooks of the Cargo Screen into the left and right side panels as shown. C. Installation is complete.</p>
	<p>Make sure Cargo Screen and hooks are fully engaged to the side trim panels.</p>